

# MZX84

MIXER ZONE



USER MANUAL

All rights reserved by Music & Lights S.r.l. No part of this instruction manual may be reproduced in any form or by any means for any commercial use.

In order to improve the quality of products, Music&Lights S.r.l. reserves the right to modify the characteristics stated in this instruction manual at any time and without prior notice.  
All revisions and updates are available in the 'manuals' section on site [www.musiclights.it](http://www.musiclights.it)

## CONTENTS

### Safety

General instructions .....	4
Warnings and installation precautions .....	4

### 1 Introduction

1.1 Features .....	5
--------------------	---

### 2 Operating elements and connections

2.1 Front Panels .....	6
2.2 Rear Panels .....	7
2.3 Block diagrams .....	8
2.5 Specifications .....	9

### 3 General criteria for installation of sound systems .....

10

---

### Packing content:

- MZX84
  - User manual
-



## WARNING!



**Before carrying out any operations with the unit, carefully read this instruction manual, and keep it with care for future reference.**

**It contains important information about the installation, usage and maintenance of the unit.**

## SAFETY

### General instruction

- The products referred to in this manual conform to the European Community Directives and are therefore marked with **CE**.
- The unit is supplied with hazardous network voltage (230V~). Leave servicing to skilled personnel only. Never make any modifications on the unit not described in this instruction manual, otherwise you will risk an electric shock.
- Connection must be made to a power supply system fitted with efficient earthing (Class I appliance according to standard EN 60598-1). It is, moreover, recommended to protect the supply lines of the units from indirect contact and/or shorting to earth by using appropriately sized residual current devices.
- The connection to the main network of electric distribution must be carried out by a qualified electrical installer. Check that the main frequency and voltage correspond to those for which the unit is designed as given on the electrical data label.
- This unit is not for home use, only professional applications.
- Make certain that no inflammable liquids, water or metal objects enter the fixture.
- Do not dismantle or modify the fixture.
- All work must always be carried out by qualified personnel. Contact the nearest sales point for an inspection or contact the manufacturer directly.
- If the unit is to be put out of operation definitively, take it to a local recycling plant for a disposal which is not harmful to the environment.

### Warnings and installation precautions

- This product in combination with amplifier, may be capable of producing dangerous sound levels that could cause permanent hearing loss. Do not operate for a long period of time at high volume level or at a level that is uncomfortable.
- If this device will be operated in any way different to the one described in this manual, it may suffer damages and the guarantee becomes void. Furthermore, any other operation may lead to dangers like short circuit, burns, electric shock, ect.
- Do not install the fixture near sources of heat.
- The fixture must be located in a place where a proper ventilation or thermal dissipation is not impeded. Do not install the fixture in a confined space.
- The output level of the amplifier must never exceed the marked sensitivity.
- Do not link the output of any amplifier channel back into another channel's input. Do not parallel or series connect an amplifier's output with any other amplifier's output.
- Make sure that the signal is correctly connected to the amplifier's input channel and set to proper input mode.
- Please turn off the power switch before pulling off the power cord.
- Before starting any maintenance work or cleaning the unit, cut off power from the main supply.
- When cleaning unit, please do not use solvents such as acetone or alcohol, since they may damage the of the unit outer finish and the printings on the panels.



## - 1 - INTRODUCTION

### 1.1 - Features

- Controls

- Front : 4 Mic/Line Input Level control (CH1-4) with 3-band EQ and selector switches.

- 4 Line Input Level control (CH5-8) with selector switches.

- 4 Output Level control with 2-band Tone control and Mute switch.

- Monitor Level with selector switches.

- Rear : 8 Gain control for each input.

- Talkover switch for CH1.

- Phantom Power switches for CH1 and CH2-4.

- Connectors

- 4 XLR Electronically Balanced jack and 1/4" phone jack for CH1-4 input.

- 4 1/4" phone jack and RCA jack for CH5-8 input.

- RJ45 jack for Remote operation.

- Euro Block for 4 LINE output.

- Indicators: Power, SIG, PEAK for each input channel and SIG, -20dB,

- 10dB, 0dB, CLIP for each output channel.

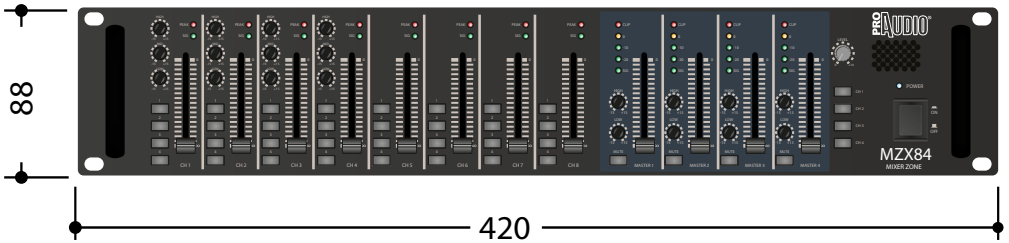

Technical drawing

Fig.1

## - 2 - OPERATING ELEMENTS AND CONNECTIONS

### 2.1 - Front Panels

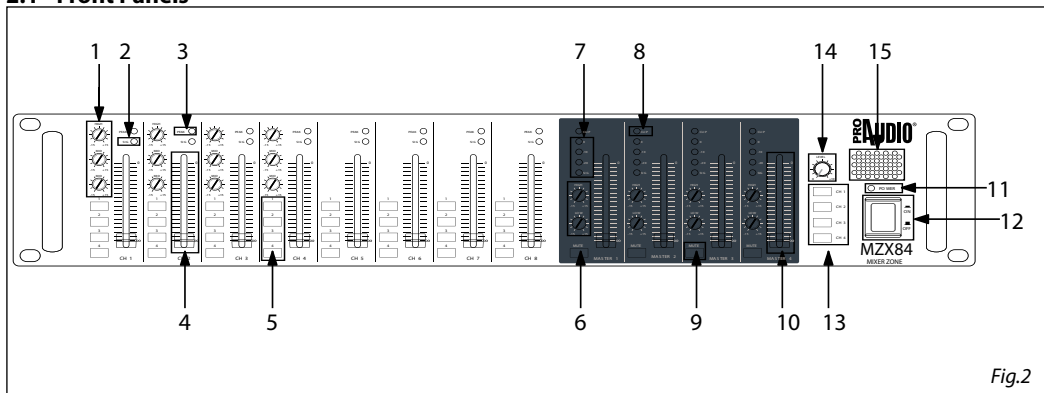

Fig.2

1. **INPUT CHANNEL EQ CONTROLS** These controls allow to equalize the input signal from -15dB to +15dB at 80Hz(LOW),2.5kHz(MID) and 12.5kHz(HIGH) for CH1~CH4.
2. **SIGNAL INDICATORS** These indicators show current input signal on the each input channels.
3. **PEAK INDICATORS** These indicators warn against overload shortly on the each input channels. We would like to recommend for users to adjust TRIM control on the rear panel when PEAK indicators are flickering to make best performance.
4. **INPUT CHANNEL FADER** These allow to adjust for each input level.
5. **OUTPUT CHANNEL SELECTORS** These selectors allow to route each input signal through out to selected output channels.
6. **OUTPUT CHANNEL EQ CONTROLS** Output channels have two band equalizer which is adjustable over a wide range as follow. HIGH :  $\pm 15$ dB at 12KHz / LOW :  $\pm 15$ dB at 80Hz
7. **OUTPUT LEVEL METER** These indicators show current output level.
8. **CLIP INDICATORS** These indicators warn against overload shortly on the each output channels. We would like to recommend for users to adjust FADER control when CLIP indicators are flickering to make best performance.
9. **MUTE SWITCH** These buttons allow to mute for each output channels.
10. **OUTPUT FADER** These faders allow to adjust the level for each output channels.
11. **POWER INDICATOR** This indicator lights when power switch is turned on.
12. **POWER SWITCH** This button is power on/off switch.
13. **MONITOR SWITCH** These switches allow you to monitor each output channel through monitor speaker.
14. **MONITOR OUTPUT CONTROL** This control allow to adjust the monitor level of monitor speaker.
15. **MONITOR SPEAKER**

2.2 - Rear Panels



Fig.3

1. AC POWER INPUT CONNECTOR A correct capacity of fuse and power cable should be applied. Please make sure the value of fuse before replacing.
2. REMOTE INPUT These RJ45 jacks allow to connect with MZR1 (wall control panel) for adjusting volume and inserting music source of remote area.
3. LINE OUTPUTS These LINE output blocks can be connected to the input of a power amplifier.



WP1 WALL CONTROL

Features

- Wall Control Panel for MZA8412 and MZX84.
- Controls
  - Volume control for Wall Panel Mic and Line input or Remote main set source.
  - Push Switch for Wall panel input or Remote main set source.
- Connectors
  - Input : XLR for Mic & RCA for Line.
  - Output : RJ 45 to connect with Remote main set on the rear.

4. TRIM CONTROLS These controls allow to accept variable input level. They have 44dB adjustable range as -50dB to -6dB for microphone input channels and -30dB to +14dB for line input channels.
5. SIGNAL INPUTS This amplifier provide several connectors for signal input and these connectors allow easy connection. The channel 1~4 are balanced line and microphone input and channel 5~8 are mono line input.
6. PRIORITY SWITCH All other input signals are muted by the input signal of channel 1 automatically when this switch pressed on.
7. PHANTOM POWER SWITCH The phantom power can be provided to each microphone input for using condenser microphone.
8. EXT.MUTE Mutes input signals fed to CH1~CH4 employing muting function by shortcircuiting at these terminals.
9. DC 24V INPUT & LINK TERMINAL If connected to DC 24V. These terminals are provided for the connection of 24V DC power source. 24V DC battery source can be connected to these terminal. The device will supply power to other device by the link output terminal.

## 2.4 - Block diagrams

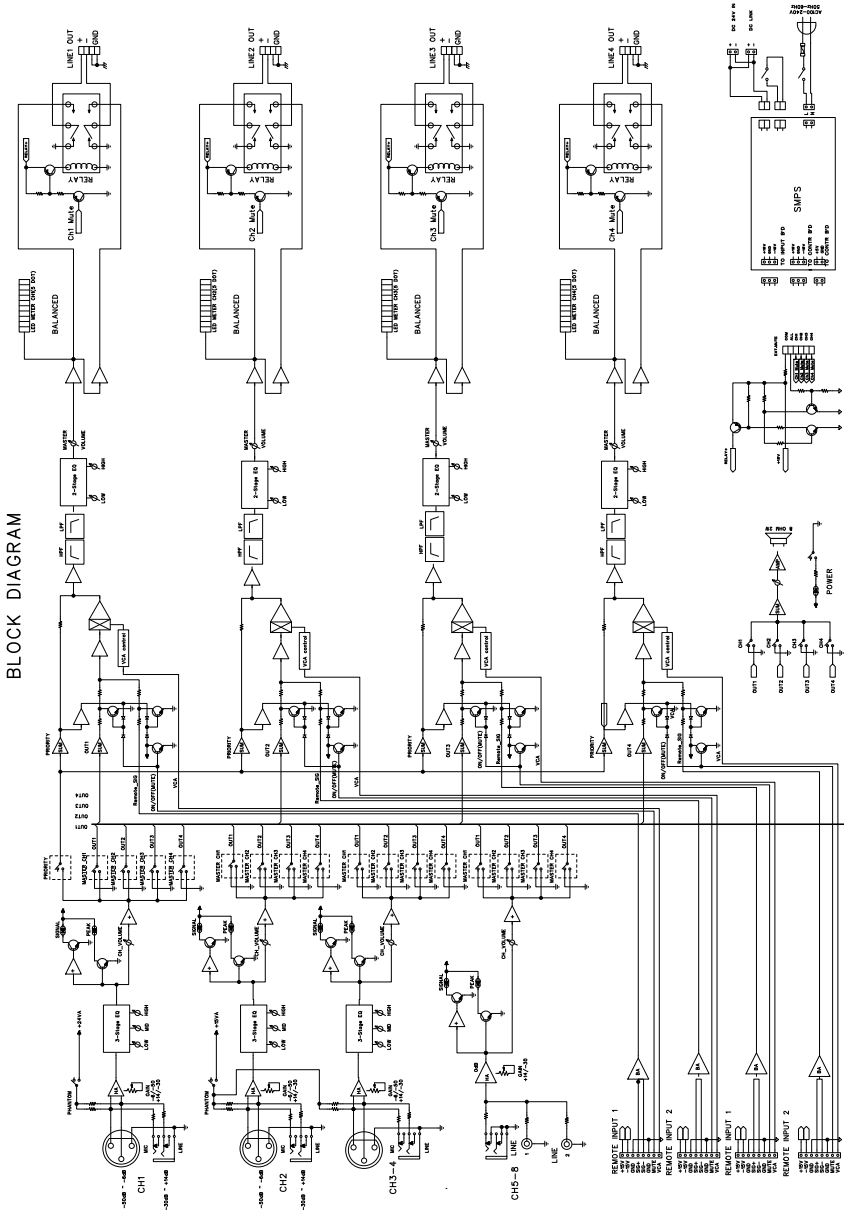

Fig.7



## 2.5 - Specifications

Technical data	<b>MZX84</b>
Rated Output Level / Impedance	0dB / 600 $\Omega$ Balanced
Input sensitivity/ impedance mic input	- 50dB~ - 6dB / 20K $\Omega$ Balanced
Input sensitivity/ impedance line input	-30dB~ + 14dB / 20K $\Omega$ Balanced
Input connections	XLR, Mic 1-4, 6.3mm jack for line 1 - 8, RCA for Line 1-4, Remote control RJ45 input 1-4
Output connections	Molex output 1-4
Frequency response	20/20.000Hz ( $\pm$ 1dB)
Distortion (THD)	<0.1% (1KHz)
Tone controls input	80 Hz, 2.5kHz, 12kHz ( $\pm$ 15dB)
Tone controls output	100 Hz, 10kHz ( $\pm$ 15dB)
Power supply	AC 100~240 Volt, 50~60Hz - DC-24V
Rack units	2U
Phantom power	+15VDC
Dimensions (WxHxD)	420x88x320 mm
Weight	9 kg

Technical data	<b>WP1</b>	
Output Level/Impedance 1V/600 $\Omega$ Balanced	1V/600 $\Omega$ Balanced	
Input sensitivity / Impedance	Mic Input	- 50dB / 20K $\Omega$ Balanced
	Line Input	-0dB / 30K $\Omega$ Balanced
Frequency Response (-1dB) 20Hz - 20kHz	20Hz - 20kHz	
T.H.D < 0.1%	< 0.1%	
Hum & Noise	EIN	> 129 dB
	Residual	> 100dB
Power Source DC $\pm$ 15V	DC $\pm$ 15V	
Weight (Net) 0.5 kg	0.5 kg	
Dimensions (W x H x D)	80 x 80 x 50mm	

### - 3 - GENERAL CRITERIA FOR INSTALLATION OF SOUND SYSTEMS

#### Introduction

This guide represents a quick introduction to the criteria for the installation of a sound system at constant voltage or constant impedance.

A sound system must be made by qualified personnel only, who must evaluate the needs of the user and the environmental characteristics of the spaces to be covered, select the speakers according to the spaces and the type of message to be broadcasted (ie: speech / music ), identify the suitable amplifier model to drive the complex of all the speakers and having an adequate number of inputs, evaluate the proper connection for the speakers and determine the section of the wiring.

#### Constant voltage systems

In terms of selection of speakers and their connection it's necessary to evaluate whether to use normal speakers with 4/8/16Ohm impedance or speakers with transformer. The decision is usually influenced by the destination of the system (supermarket, disco , pub, house, ...) and by the number of speakers to employ. Constant voltage speakers are normally used into situations where it is necessary to install several speakers with low power to get a homogeneous distribution of audio and overall low volume. The classic example is the sound installation in airports or supermarkets. In these situations several speakers are usually placed within a short distance between them, normally a volume low enough to not disturb and a frequency covering the entire area with same sound pressure.

#### Differences between 4/8/16 Ohms systems and constant voltage systems

The 4/8/16Ohm systems are affected by problems of impedances:

- speakers connected in "series" mode add their impedance (example: 40Ohm + 40Ohm = 80Ohm)
- speakers connected in "parallel" mode divide their impedance (example: 80Ohm // = 80Ohm 40Ohm)

In the following pictures find a few examples of connections: series, parallel, series + parallel. Also the applicable power is reported according to type and impedance of each speaker. Please note polarity indicated for each speaker. Constant voltage systems use speakers equipped with transformer. Normally they can be configured on 2 or more different maximum power levels. In this type of system only 2 conductors are employed: the black one is connected to the negative terminal (usually marked by "0" or "COM"), the red one is connected to one of the contacts (50V, 70V, 100V). The amplifier driving all speakers will be connected to such 2 wires paying attention that right polarities are respected.

Please note that:

- Voltage selected on speaker transformer must match the voltage selected on the amplifier.
- Total sum of speakers power must not exceed power of the amplifier.
- To ensure a correct reproduction of the audio signal it is important to setup the connection with no phase shifts: the connection between positive and negative poles of the amplifier must match the polarity on speaker transformer.
- It is important that cables have an adequate section: increasing total length of the sound installation involves increasing of cable section to avoid distortion or signal loss.
- Cables for connection of the speakers should be passed separately from other electrical or microphone cables, to avoid ground loops or triggers of any kind.
- It's always important to use cables with twisted wires

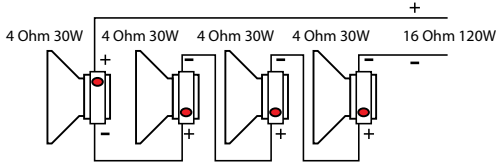

SERIES CONNECTION

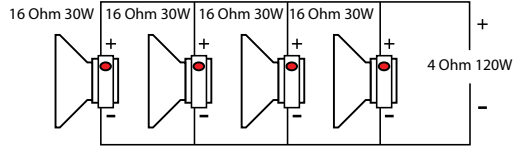

PARALLEL CONNECTION

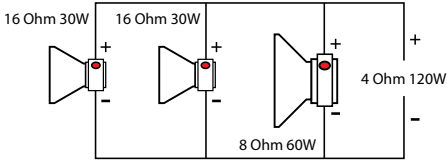

PARALLEL CONNECTION

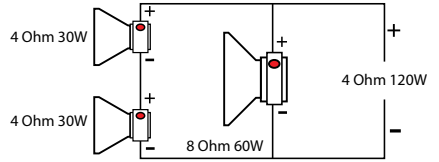

SERIES + PARALLEL CONNECTION

**MUSIC & LIGHTS S.r.l.**

---

Via Appia, km 136,200 - 04020 Itri (LT) - ITALY  
Phone +39 0771 72190 - Fax +39 0771 721955

[www.musiclights.it](http://www.musiclights.it) - email: [info@musiclights.it](mailto:info@musiclights.it)

ISO 9001:2008 Certified Company

**PROAUDIO** is a brand of Music & Lights S.r.l. company.

**PROAUDIO** è un brand di proprietà della Music & Lights S.r.l.

©2017 Music & Lights S.r.l.

