

# Eris™ Series E4.5

High-Definition Near Field Studio Monitors

Owner's Manual

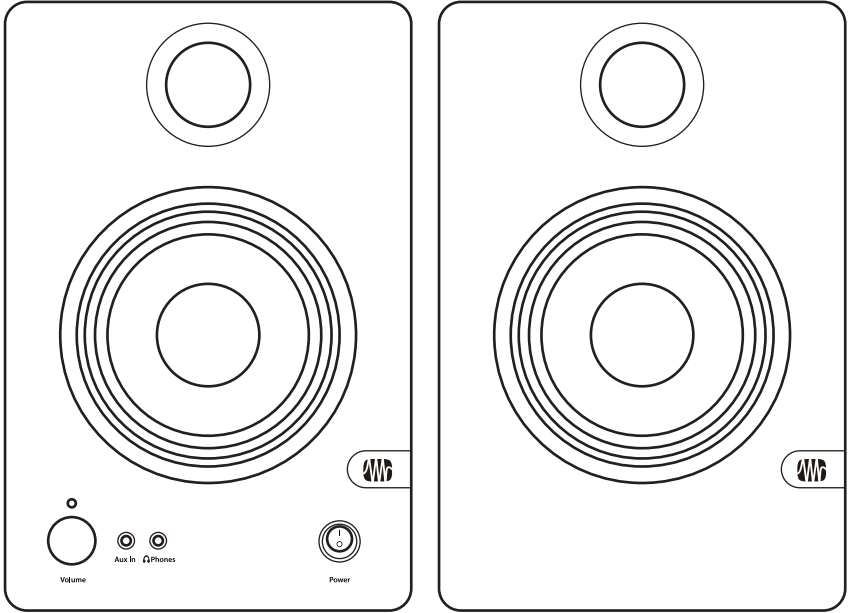

English

Español

Deutsch

Français

# Table of Contents

## **1. Overview — 1**

- 1.1. Introduction — 1
- 1.2. Summary of Eris E4.5 Features — 2
- 1.3. What's in the Box — 3

## **2. Hookup — 4**

- 2.1. Rear Panel Connections and Controls — 4
  - 2.1.1. Inputs — 4
  - 2.1.2. Power — 5
  - 2.1.3. Acoustic Tuning Controls — 5
  - 2.1.4. Speaker connections — 6
- 2.2. Front-Panel Connections — 6
- 2.3. Hookup Diagram — 7

## **3.0 Tutorials — 8**

- 3.1. Monitor Placement — 8
- 3.2. Level Setting — 9
- 3.3. Equalizer Setting Suggestions — 9
- 3.4. Acoustic Space Setting Suggestions — 10

## **4. Resources — 11**

- 4.1. Technical Specifications — 11
- 4.2. Troubleshooting — 11
- 4.3. PreSonus Limited Warranty — 12

# 1. Overview

## 1.1. Introduction

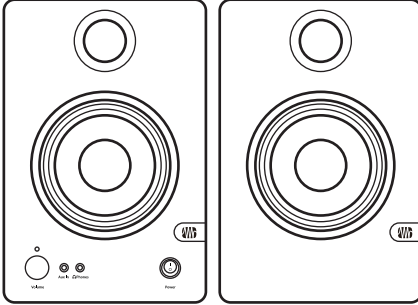

**Thank you** for purchasing the PreSonus® Eris™ E4.5 studio monitors. Eris E4.5 active near-field monitors offer excellent performance at a reasonable price for budget-conscious personal studios, with features normally reserved for more expensive monitors.

We encourage you to contact us at +1-225-216-7887 (Monday-Friday, 9 a.m. to 5 p.m. Central Time) with questions or comments regarding your PreSonus Eris E4.5 studio

monitors. PreSonus Audio Electronics is committed to constant product improvement, and we value your suggestions highly. We believe the best way to achieve our goal is by listening to the real experts: our valued customers. We appreciate the support you have shown us through the purchase of this product and are confident that you will enjoy your Eris E4.5 studio monitors!

**ABOUT THIS MANUAL:** We suggest that you use this manual to familiarize yourself with the features, applications, and connection procedures for your Eris E4.5s before connecting them to the rest of your studio gear. This will help you avoid problems during installation and setup.

Throughout this manual you will find **Power User Tips** that can quickly make you an Eris expert. In addition to the Power User Tips, you will find several tutorials that cover monitor placement, as well as setting the input level, EQ, and Acoustic Space controls.

English

Español

Deutsch

Français

## 1.2. Summary of Eris E4.5 Features

- 1" (22 mm) silk-dome tweeter
- 4.5" Kevlar woofer
- Peak SPL: 100 dB
- Frequency response: 70 Hz to 20 kHz
- Class A/B amplifier
- Balanced ¼" TRS and unbalanced RCA inputs
- 1/8" headphone output
- 1/8" stereo Auxiliary input
- Front-panel volume control
- Rear bass-reflex port
- High-frequency shelf EQ with  $\pm 6$  dB of boost/cut centered at 10 kHz
- Mid-frequency peak EQ with  $\pm 6$  dB of boost/cut centered at 1 kHz
- Low-frequency cutoff switch (flat, 80 Hz, 100 Hz) with -12 dB/octave slope
- Acoustic Space switch (0, -2 dB, -4 dB) to compensate for bass boost near a wall

English

Español

Deutsch

Français

### 1.3. What's in the Box

In addition to this manual, your Eris E4.5 package contains the following:

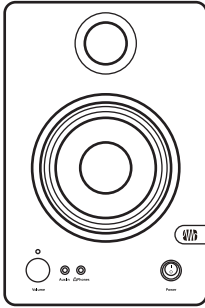

- (1) PreSonus Eris E4.5 active studio monitor

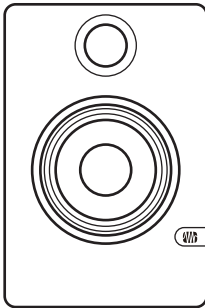

- (1) PreSonus Eris E4.5 passive studio monitor

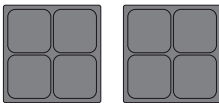

- (1) 1.5m TRS 1/8" to 2 RCA cable
- (1) 1.5m TRS 1/8" stereo cable
- (1) 2m bare-wire speaker cable
- (8) Foam feet, (4) to be placed on the bottom of each speaker to improve isolation

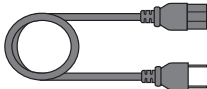

- (1) Power cable

## 2. Hookup

### 2.1. Rear Panel Connections and Controls

Each Eris E4.5 pair consists of one active E4.5 and one passive E4.5. Nearly every connection is located exclusively on the active Eris E4.5. This speaker provides signal and power for the passive E4.5. The exceptions are the bare-wire connectors, which send power and signal from the active speaker to the passive speaker.

#### 2.1.1. Inputs

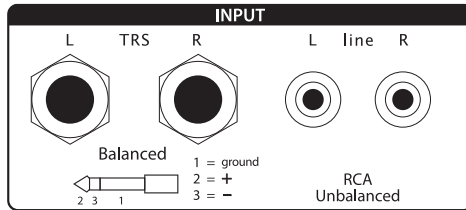

**Line-level Inputs.** The Eris E4.5 active monitor provides a choice of two pairs of inputs: left and right balanced  $\frac{1}{4}$ " TRS and left and right unbalanced RCA. These inputs accept a line-level signal from an audio source and feed that signal to the each monitor's built-in power amplifier. These inputs are provided to enable flexible connectivity, not for connecting multiple sources to your speakers simultaneously.

**Power User Tip:** The left inputs send signal to the active E4.5's amplifier, and the right inputs send signal to the amplifier that powers the passive E4.5. PreSonus recommends that the active E4.5 be placed on the left side of your mix space and the passive E4.5 be placed on the right. However, if you prefer to have the controls located on your active monitor placed on the right side of your workspace, be sure to reverse the inputs from your audio source to maintain the correct stereo image.

**Note:** These controls are only available on the active E4.5.

## 2.1.2. Power

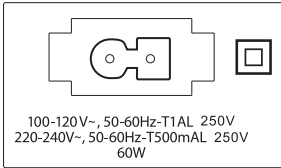

**IEC Power Connection.** The Eris E4.5 accepts a standard IEC C7 power cord. The power switch is located on the front panel of the active E4.5.

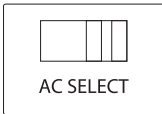

**AC Select Switch.** The input-power voltage is set at the factory to correspond with the country to which it was shipped. Change the setting on this switch only if you are using your Eris speakers in a country that uses a different standard voltage than is used in the country where you purchased your Eris E4.5.

**Note:** These controls are only available on the active E4.5.

## 2.1.3. Acoustic Tuning Controls

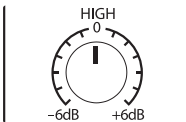

**High.** Boosts or cuts all frequencies above 10 kHz by  $\pm 6$  dB.  
*Power User Tip:* The High control on the Eris E4.5 is a high-shelf EQ and attenuates or boosts frequencies above 10 kHz. This EQ is much like the treble control on a car stereo: It raises or lowers the gain on all frequencies above the specified cutoff frequency. Shelving EQs can make big changes to the sound very quickly by adding or removing an entire range of frequencies.

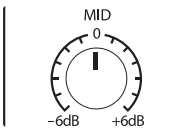

**Mid.** Boosts or cuts frequencies around 1 kHz by  $\pm 6$  dB  
*Power User Tip:* The Mid control is a peak EQ that lets you boost or cut a specified frequency band (in this case, a band about two octaves wide, centered at 1 kHz). It's capable of more subtle changes.

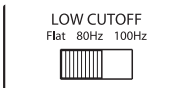

**Low Cutoff.** Rolls off the level of all frequencies below the specified frequency (80 or 100 Hz) at a slope of -12 dB/octave. This can be defeated by setting it to Flat, in which case, the monitor's natural roll-off takes over.



**Acoustic Space.** Cuts the level of all frequencies below 1 kHz by the specified amount (-2 or -4 dB) to compensate for the bass boost that occurs when the monitor is placed near a wall or corner. This can be defeated by setting it to 0 dB.

**Note:** These controls are only available on the active E4.5.

### 2.1.4. Speaker connections

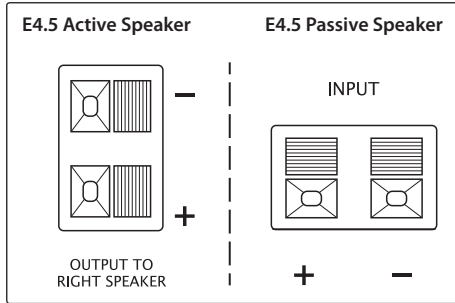

**Bare-wire connectors.** This connection is used to power and send signal to the passive E4.5. Be sure to connect the positive and negative connections on your active E4.5 to the positive and negative connections, respectively, on the passive E4.5 (i.e., connect positive to positive and negative to negative).

## 2.2. Front-Panel Connections

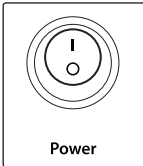

**Power Switch.** This is the On/Off switch. The LED above the volume control indicates power status.

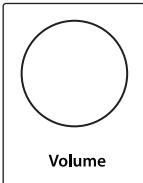

**Volume.** Sets the volume level of the input signal before it is amplified. This is also the volume control for the front-panel headphone amp.

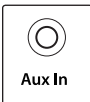

**Aux In.** This stereo 1/8" jack can be used to patch in an MP3 player for a quick reference check.

**Power User Tip:** This input will sum with the inputs on the back panel.



**Headphone Out.** This headphone output is controlled by the Level knob.

**Power User Tip:** When the headphone output is connected, audio will be muted to your E4.5 speakers. This can be very useful when you're recording at your desk!

**Note:** These controls are only available on the active E4.5.



## 2.3. Hookup Diagram

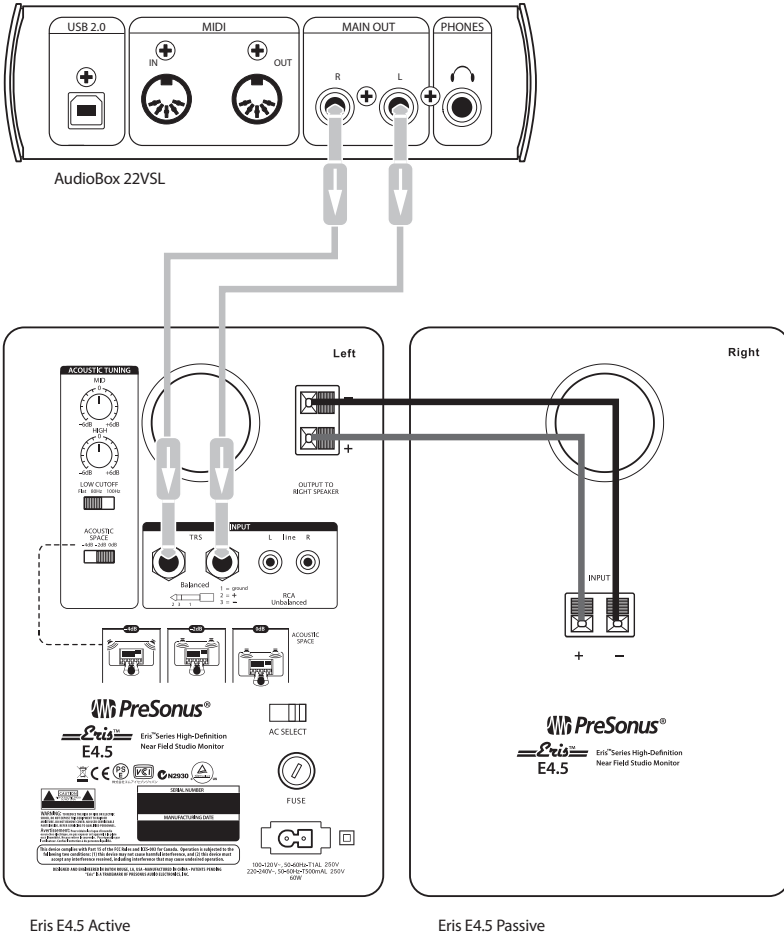

English

Español

Deutsch

Français

## 3.0 Tutorials

### 3.1 Monitor Placement

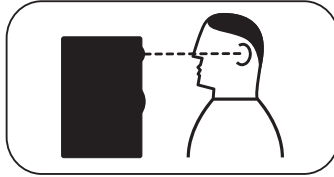

Ideally, near-field monitors should be placed so that the tweeters are at the same height as your ears when you are mixing.

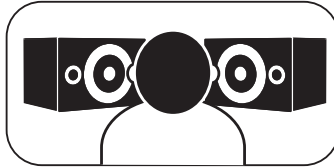

Eris speakers can be placed vertically or horizontally; when placed horizontally, they should form a mirror-image pair, with the tweeters on the outside.

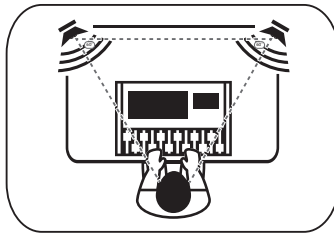

The speakers should be separated so that the tweeters form an equilateral triangle with your head. The monitors should be “toed in,” or angled, so that they are pointed at you, not pointed straight ahead.

### 3.2 Level Setting

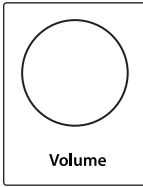

Make sure that the gain controls on your audio source have been optimized for maximum signal level and minimum noise. This process is called “gain staging,” and you can learn about it from many online sources. You should always set the volume on your Eris monitor so that all other level controls in the system needn't be turned way up or way down to achieve a comfortable listening volume.

If you properly gain-stage your audio source, setting the Eris Volume to 12 o'clock or slightly lower should work fine.

Once the monitor's volume control is set, leave it alone; don't use it as a system-volume control. Leave that job to your audio device's output-level control.

### 3.3 Equalizer Setting Suggestions

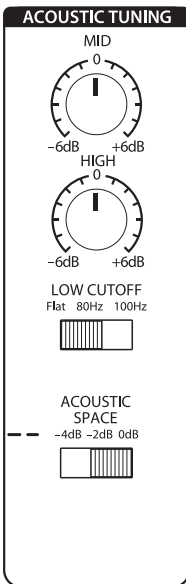

The Eris 4.5 provides three EQ controls in its Acoustic Tuning section: High, Mid, and Low Cutoff. (There's also an Acoustic Space control, which is covered in the next section.) In general, setting the High control to 0 (no boost or cut) will produce the best results. However, if the sound is generally too bright or shrill, try turning this control down below 0; if the sound is too dull and lifeless, try turning it up above 0. It's always better to cut than to boost and to use the smallest cut or boost needed to get the job done.

The Mid control is a mid-frequency peak filter that boosts or cuts frequencies centered on 1 kHz and extending about one octave above and below that frequency. Again, setting this control to 0 will generally produce the best results. If you want to emulate a car stereo, try turning it down below 0 to approximate the common “smiley face” EQ curve. On the other hand, if you want to emulate a cheap portable radio, try turning it up above 0. Try not to boost much, since this can add noise to the signal.

The Low Cutoff control rolls off the low frequencies below the specified frequency (80 or 100 Hz). Engage this control if you are using a subwoofer in conjunction with the Eris E4.5 monitors, and set it to the same frequency as the crossover to the subwoofer. If you're not using a subwoofer, set the control to Flat. If you want to emulate a cheap radio, engage this control at 80 or 100 Hz while boosting the Mid control.

**Power User Tip:** Do not use the EQ controls on your Eris monitor to correct problems in your mix. While this changes what you hear in the control room, it has no effect on your recorded audio.

### 3.4 Acoustic Space Setting Suggestions

When a monitor is placed close to a wall, or in a corner, the low frequencies tend to be emphasized more than if the monitor is far from any room boundary; this effect is called “boundary bass boost.” It is most pronounced if the monitor is in a corner and less pronounced, but present, if the monitor is near one wall.

To compensate for this bass boost, the Eris E4.5 provides an Acoustic Space switch that cuts all frequencies below 1kHz by a fixed amount.

If the monitors are close to the corners of the room, start by setting the Acoustic Space switch to -4 dB, which provides the most bass attenuation.

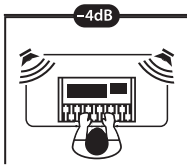

If the monitors are close to the back wall, try setting the Acoustic Space switch to -2 dB for less attenuation.

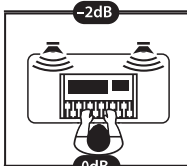

If the monitors are far from any wall, there will be no bass boost, so set the switch to 0 dB.

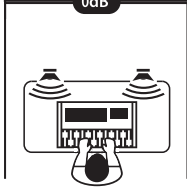

English

Español

Deutsch

Français

## 4. Resources

### 4.1. Technical Specifications

#### Inputs

2 balanced ¼" TRS, 2 unbalanced RCA, 1 stereo 1/8"

#### Performance

Frequency Response	70 Hz to 20 kHz
Crossover Frequency	2.8 kHz
Amplifier Power	25W per speaker
Peak SPL at 1m	100 dB
Input Impedance	10 kΩ

#### User Controls

Volume Range	A-Type Taper
MF Control	Variable (-6 to +6 dB)
HF Control	Variable (-6 to +6 dB)
Low Cut	Flat, 80 Hz, 100 Hz
Acoustic Space	Flat, -2 dB, -4 dB
Protection	RF interference, output-current limiting, over-temperature, turn on/off transient, subsonic filter, external mains fuse

#### Power

100-120V ~50/60 Hz or 220-240V ~50/60 Hz

#### Physical

Cabinet	Vinyl laminated MDF
Dimensions (WxHxD)	6.42" x 9.45" x 7.09" (163 mm x 241 mm x 180 mm)
Weight (per pair)	13 lbs (5.9 kg)

### 4.2. Troubleshooting

**No Power.** First ensure that your active Eris E4.5 is plugged in. If it's connected to a power conditioner, verify that the power conditioner is turned on and functioning.

**No audio.** If your Eris E4.5 appears to power on but you hear no sound when playing audio from your audio source (the lights are on but nobody's home), first make sure that the cable connecting your audio source to the monitor is working correctly. Also, verify that the volume control is set to provide enough amplitude for the signal.

If only the passive E4.5 is not passing audio, check your speaker-wire connections and verify that the bare wire is fully inserted into each connection.

### 4.3. PreSonus Limited Warranty

**Hum.** Usually, hum is caused by a ground loop. Verify that all audio equipment is connected to the same power source.

**Sound is thin.** If the sound of the speakers seems thin and brittle, check that your speaker wires are connected correctly (i.e., the positive/red connection on the active Eris E4.5 is connected to the positive/red connection on the passive Eris E4.5 and the negative/black connection on each is connected to the negative/black connection on the other).

### 4.3. PreSonus Limited Warranty

PreSonus Audio Electronics, Inc., warrants this product to be free of defects in material and workmanship for a period of one year from the date of original retail purchase. This warranty is enforceable only by the original retail purchaser. To be protected by this warranty, the purchaser must complete and return the enclosed warranty card within 14 days of purchase. During the warranty period PreSonus shall, at its sole and absolute option, repair or replace, free of charge, any product that proves to be defective on inspection by PreSonus or its authorized service representative. If you are located in the USA and need warranty repair, please submit an online technical support request at <http://support.presonus.com> to receive a return-authorization number and shipping information. If you are located outside of the USA, please contact the PreSonus distributor for your region for warranty repairs. All inquiries must be accompanied by a description of the problem. All authorized returns must be sent to the PreSonus repair facility postage prepaid, insured, and properly packaged. PreSonus reserves the right to update any unit returned for repair. PreSonus reserves the right to change or improve the design of the product at any time without prior notice. This warranty does not cover claims for damage due to abuse, neglect, alteration, or attempted repair by unauthorized personnel and is limited to failures arising during normal use that are due to defects in material or workmanship in the product. Any implied warranties, including implied warranties of merchantability and fitness for a particular purpose, are limited in duration to the length of this limited warranty. Some states do not allow limitations on how long an implied warranty lasts, so the above limitation may not apply to you. In no event will PreSonus be liable for incidental, consequential, or other damages resulting from the breach of any express or implied warranty, including, among other things, damage to property, damage based on inconvenience or on loss of use of the product, and, to the extent permitted by law, damages for personal injury. Some states do not allow the exclusion of limitation of incidental or consequential damages, so the above limitation or exclusion may not apply to you. This warranty gives you specific legal rights, and you may also have other rights, which vary from state to state. This warranty only applies to products sold and used in the United States of America. For warranty information in all other countries, please refer to your local distributor.

PreSonus Audio Electronics, Inc.  
7257 Florida Blvd.  
Baton Rouge, LA 70806 USA  
1-225-216-7887  
[www.presonus.com](http://www.presonus.com)

English

Español

Deutsch

Français

## Added bonus: PreSonus' previously Top Secret recipe for... **Rice Dressing**

### **Ingredients:**

- 1 lb ground beef
- 1 lb chopped chicken liver
- 1 onion (diced)
- 2 green peppers (diced)
- 4-6 celery stalks (diced)
- 2 garlic cloves (minced)
- ¼ C. chopped fresh parsley
- 3 C. chicken stock
- 6 C. cooked rice
- 1 Tbs. oil
- Salt and pepper to taste
- Cayenne pepper to taste

### **Cooking Instructions:**

1. In a large pot, heat oil on medium high and add meat, salt, and pepper to taste. Stir until meat begins to brown.
2. Lower heat and add all vegetables. Cook until onions are transparent and celery is very tender. Add stock as necessary to prevent burning.
3. Stir in cooked rice. Add remaining stock and simmer on low until ready to serve.

# Eris™ Series E4.5

## High-Definition Near Field Studio Monitors

### Owner's Manual

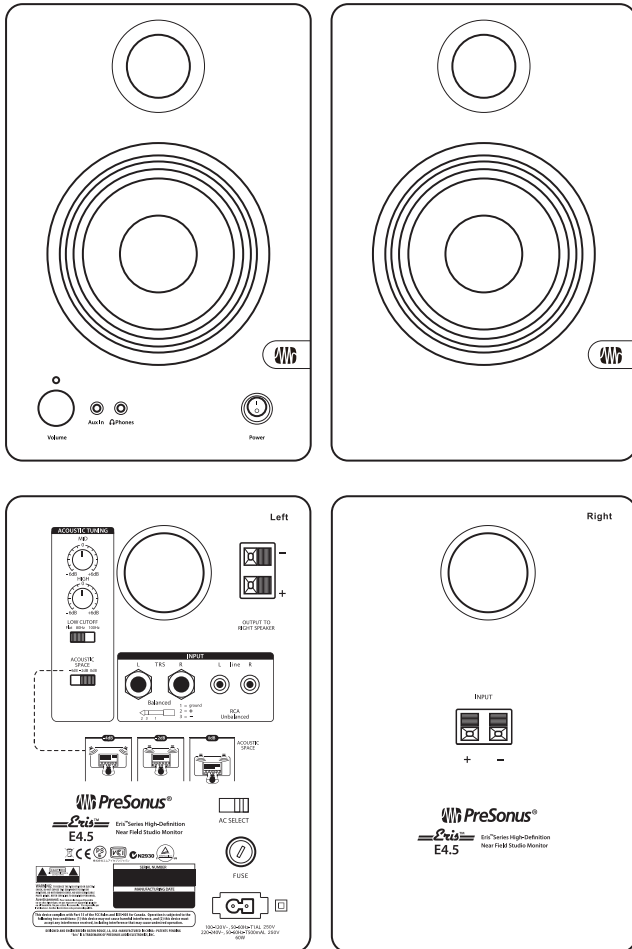

18011 Grand Bay Ct. • Baton Rouge,  
Louisiana 70809 USA • 1-225-216-7887  
[www.presonus.com](http://www.presonus.com)

Part# 820-GE40027-B