

PHI-3

Phase Shifter

Owner's Manual

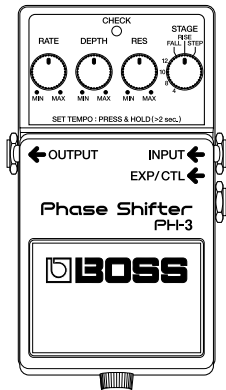

BOSS

Thank you, and congratulations on your choice of BOSS PH-3 Phase Shifter.

Before using this unit, carefully read the sections entitled: “USING THE UNIT SAFELY” and “IMPORTANT NOTES” (Owner’s manual p. 25 – p. 31; p. 4 – p. 5). These sections provide important information concerning the proper operation of the unit. Additionally, in order to feel assured that you have gained a good grasp of every feature provided by your new unit, Owner’s manual should be read in its entirety. The manual should be saved and kept on hand as a convenient reference.

Copyright © 2000 BOSS CORPORATION

All rights reserved. No part of this publication may be reproduced in any form without the written permission of BOSS CORPORATION.

Main Features

- In addition to the standard four setting types available on previous phasers (4-/8-/10-/12-stage), the PH-3 adds further features, including new RISE and FALL effects and a STEP setting which changes the effect in steps, for a total of seven switchable phase effects (an effect that adds a cyclic sensation to the sound).
- New RISE/FALL features give you continuous rising and falling effects unavailable with previous phasers.
- You can use the PH-3's pedal to set the RATE to the tempo. This makes it easy to sync to songs (tempo and measure), formerly a difficult process.
- Includes an expression/control jack.
You can connect an expression pedal (Roland EV-5; sold separately) to this jack and make continuous changes to the RATE for a rotary speaker-like sound, while connecting a foot switch (BOSS FS-5U; sold separately) allows you to match the rate to the tempo.

IMPORTANT NOTES

In addition to the items listed under “USING THE UNIT SAFELY” on p. 25, please read and observe the following:

Power Supply: Use of Batteries

- Do not use this unit on the same power circuit with any device that will generate line noise (such as an electric motor or variable lighting system).
- The AC adaptor will begin to generate heat after long hours of consecutive use. This is normal, and is not a cause for concern.
- The use of an AC adaptor is recommended as the unit’s power consumption is relatively high. Should you prefer to use batteries, please use the alkaline type.
- Batteries should always be installed or replaced before connecting any other devices. This way, you can prevent malfunction and/or damage to speakers or other devices.

- A battery was installed in the unit before it left the factory. The life of this battery may be limited, however, since its primary purpose was to enable testing.
- Before connecting this unit to other devices, turn off the power to all units. This will help prevent malfunctions and/or damage to speakers or other devices.

Placement

- Using the unit near power amplifiers (or other equipment containing large power transformers) may induce hum. To alleviate the problem, change the orientation of this unit; or move it farther away from the source of interference.
- This device may interfere with radio and television reception. Do not use this device

in the vicinity of such receivers.

- To avoid possible breakdown, do not use the unit in a wet area, such as an area exposed to rain or other moisture.

Maintenance

- For everyday cleaning wipe the unit with a soft, dry cloth or one that has been slightly dampened with water. To remove stubborn dirt, use a cloth impregnated with a mild, non-abrasive detergent. Afterwards, be sure to wipe the unit thoroughly with a soft, dry cloth.
- Never use benzene, thinners, alcohol or solvents of any kind, to avoid the possibility of discoloration and/or deformation.

Additional Precautions

- Use a reasonable amount of care when using the unit's buttons, sliders, or other controls; and when using its jacks and

connectors. Rough handling can lead to malfunctions.

- When connecting / disconnecting all cables, grasp the connector itself—never pull on the cable. This way you will avoid causing shorts, or damage to the cable's internal elements.
- To avoid disturbing your neighbors, try to keep the unit's volume at reasonable levels. You may prefer to use headphones, so you do not need to be concerned about those around you (especially when it is late at night).
- When you need to transport the unit, package it in the box (including padding) that it came in, if possible. Otherwise, you will need to use equivalent packaging materials.
- Use only the specified expression pedal (Roland EV-5; sold separately). By connecting any other expression pedals, you risk causing malfunction and/or damage to the unit.

Feature Names and Functions

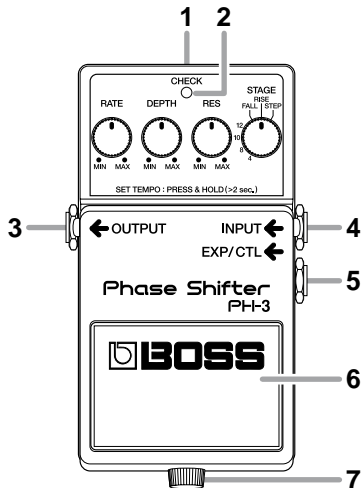

1. AC adaptor Jack

An AC adaptor (BOSS PSA-series: sold separately) can be connected to this jack. If an AC adaptor is used, you will be able to play for extended periods without worrying about battery life.

- * *As soon as you connect the AC adaptor, the unit is turned on.*
- * *If there is the battery in the unit while an AC adaptor is being used, normal operation will continue should the line voltage be interrupted (power blackout or power cord disconnection).*
- * *If you are going to use an AC adaptor, be sure to use the specified unit (BOSS PSA-Series).*

2. CHECK Indicator

Combination indicator that shows the effect's on/off status, tempo (in Tempo mode: p. 13), and Battery Check function. The indicator is lit when the effect is on, thereby allowing you to check whether the effect is on or off.

- * *If the indicator dims when the effect is on or when the tempo is being displayed, it means that the battery is running out of reserve; when this occurs, replace with fresh batteries. For instructions on changing the batteries, refer to "Changing the Battery" (p. 17).*
- * *The CHECK indicator shows whether the effect is being applied or not, and is used to indicate other effects. It does not indicate whether the power to the device is on or not.*

3. OUTPUT Jack

This output jack is connected to an amplifier or other effects device.

4. INPUT Jack

This jack accepts input signals (coming from a guitar, some other musical instrument, or another effects unit).

- * *When a battery is used, the INPUT jack also functions as a power switch. When a plug is inserted into the INPUT jack, the power will be turned on. When the plug is pulled out, the power will be turned off. When you are not using the unit, pull the plug out of the INPUT jack.*

5. EXP/CTL Jack

Accepts connection of an expression pedal (Roland EV-5; sold separately) or momentary-type foot switch (BOSS FS-5U; sold separately).

Use the EV-5 to change the RATE continuously.

Setting tempos is easy with the FS-5U.

* Refer to “Using the EXP/CTL Jack” (p. 15).

6. Pedal Switch

Used for switching effects on/off, and for inputting the tempo.

When the effect is on, be sure to start any changes with the filter at the lowest setting.

* For inputting the tempo, refer to “Setting the Tempo with the PH-3’s Pedal Switch” (p. 13).

7. Thumbscrew

When this screw is loosened, the pedal will open, allowing you to change the battery.

* For the procedure, refer to “Changing the Battery” (p. 17).

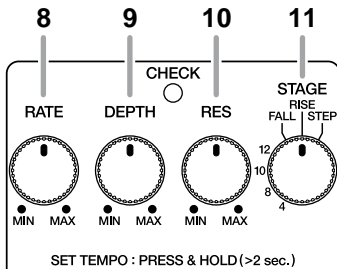

8. RATE Knob

Adjusts the speed at which the filter changes. When set to MIN, the filter remains off.

9. DEPTH Knob

Adjusts the depth of the filter change. The filter effect stops when this is set to MIN with the STAGE switch set to anything besides FALL or RISE.

10. RES (Resonance) Knob

Adjusts the strength of the filter effect. The effect sound becomes stronger the further the knob is turned clockwise.

** Raising the RES setting (turning it clockwise) makes it easier for the sound to become distorted. If it appears that the sound is becoming distorted, try lowering the RES setting.*

11. STAGE Switch

Selects the number of phase steps and the phase type. The higher the number, the more depth the phaser effect has.

- 4:** 4-stage phaser; a light, vintage phaser effect with a classic feel.
- 8:** 8-stage phaser that gives a balanced phaser sound.
- 10:** 10-stage phaser providing a deep phaser effect.
- 12:** 12-stage phaser, with two six-stage phasers connected in series for a powerful phaser effect.
- FALL:** Phase effect featuring a continuously falling sensation.
- RISE:** Phase effect that imparts a continuously rising sensation.
- STEP:** Phase effect whereby filter modifications occur in a non-consecutive manner. This can provide some really unique, illusional effects.

Connections

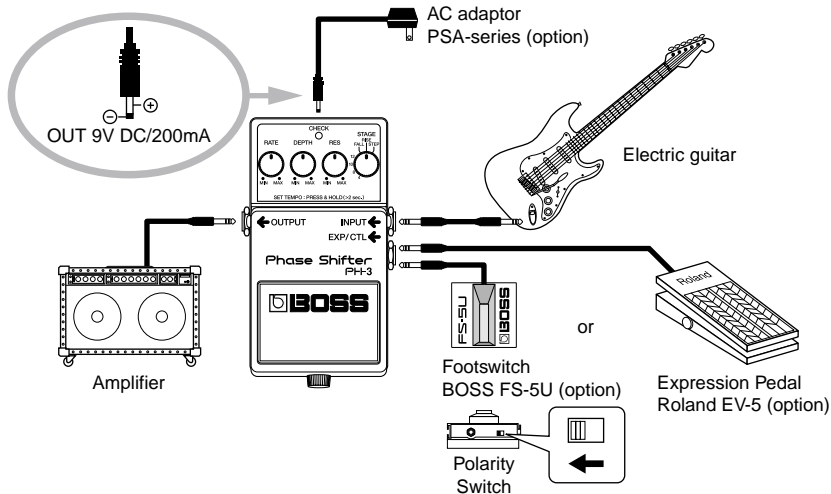

- * *Inserting a plug into the INPUT Jack will automatically switch the unit on.*
- * *To prevent malfunction and/or damage to speakers or other devices, always turn down the volume, and turn off the power on all devices before making any connections.*
- * *If there are batteries in the unit while an AC adaptor is being used, normal operation will continue should the line voltage be interrupted (power blackout or power cord disconnection).*
- * *Use only the specified expression pedal (Roland EV-5; sold separately). By connecting any other expression pedals, you risk causing malfunction and/or damage to the unit.*
- * *Once you've gotten hooked up correctly (p. 10), be sure to observe the following order when switching on the power to your equipment. By turning on devices in the wrong order, you risk causing malfunction and/or damage to speakers and other devices.*
When powering up: Turn on the power to your guitar amp last.
When powering down: Turn off the power to your guitar amp first.

Operation

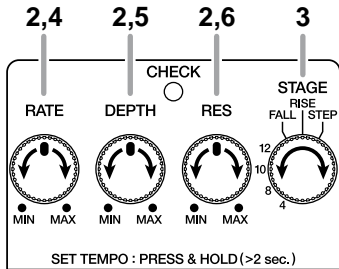

1. When you have finished making the connections (p. 10), press the pedal switch to turn the effect on (the CHECK indicator is lit).
2. Set the RATE, DEPTH, and RES knobs at the center position.

3. Use the STAGE switch to select the stage type.
4. With the RATE knob, adjust the speed of the filter change.
 - * When set to MIN, the filter remains off.
5. With the DEPTH knob, adjust the depth of the filter change.
 - * The filter effect stops when this is set to MIN with the STAGE switch set to anything besides FALL or RISE.
6. With the RES (Resonance) Knob, adjust the strength of the filter effect.
 - * Raising the RES setting (turning it clockwise) makes it easier for the sound to become distorted. If it appears that the sound is becoming distorted, try lowering the RES setting.

Setting the Tempo with the PH-3's Pedal Switch

** RATE cycles for use with the tempo settings can be made in the range of 0.2–16 seconds.*

- 1.** Step on, and continue depressing the PH-3's pedal switch for at least two seconds.

If the pedal switch is pressed when the effect is on, the CHECK indicator goes out, and the effect is turned off for two seconds.

If the pedal switch is pressed when the effect is off, the CHECK indicator turns red, and the effect is turned on for two seconds.

- * For switching without the normal stress and hassle of turning effects on and off, when you go into the tempo setting mode while the effect is on, the effect is first switched off for two seconds, and the PH-3 switches to tempo setting mode.*

- 2.** The CHECK indicator then flashes in red and green, and the tempo can then be set with the effect on.

** Here, the tempo is indicated by the value set with the RATE knob.*

- 3.** Press the PH-3's pedal switch in timing with the tempo.

The CHECK indicator then flashes in red and green in time with the tempo.

** When the pedal switch is pressed, the filter is completely lowered (except when set to RISE or FALL). When using this, even if the RATE (as shown by the flashing CHECK indicator) is off slightly from the tempo, you can match the RATE to the tempo with one step on the PH-3's pedal.*



Setting the RATE near the desired tempo beforehand allows you to make faster and more natural tempo settings.

4. Press and continue holding the PH-3's pedal switch for two seconds or longer to finish setting the tempo. The effect goes on, and instead of flashing in red and green, the CHECK indicator will light steadily in red.
 - * *When you have finished setting the tempo, the RATE changes to the value for the tempo setting made with the pedal, so the value will differ from the value indicated by the RATE knob.*
 - * *When changed with the RATE knob, the tempo is then the same as the value for the RATE knob.*

Using the EXP/CTL Jack

* When an EV-5 or FS-5U is connected to the EXP/CTL jack, the PH-3's own pedal switch then only turns the effect on and off.

* When disconnecting from the EXP/CTL jack, the RATE (tempo) settings used up to that point are cleared, with the RATE knob setting then becoming effective.

● When Connecting the (Optional) Roland EV-5

The RATE settings can be adjusted with the EV-5.

You can change from the minimum RATE value set by the EV-5's Minimum Value to the value set with the PH-3's RATE knob.

1. Connect the EV-5 to the EXP/CTL jack, and press the pedal completely forward. The adjustment made with the RATE knob in this condition determines the maximum RATE value when controlled with the EV-5.
2. Return (raise) the pedal completely back so the heel is down. The adjustment made with the RATE knob at this point determines the minimum RATE value when controlled with the EV-5.



● When Connecting the (Optional) BOSS FS-5U

The tempo can be set with the FS-5U. Concerning how to make the tempo settings, refer to steps 3 and 4 under “Setting the Tempo with the PH-3’s Pedal Switch” (p. 13). Simply substitute “FS-5U” where it says “PH-3’s pedal switch.”

- * *The PH-3's pedal switch switches the effect on and off. When the effect is on, the CHECK indicator flashes alternately in red and green.*
- * *If you turn the RATE after setting the tempo with the FS-5U, the RATE knob value is then adjusted.*
- * *You can also make the tempo settings with the effect off.*

* *Set the polarity switch of the connected the FS-5U as shown in the figure below.*

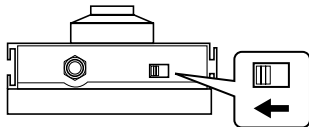

Polarity switch

Changing the Battery

When the CHECK indicator goes dim or no longer lights while an effect is on, it means that the battery is nearly dead and must be replaced. Replace the battery following the steps below.

** For best results (i.e., longest usable life) use an alkaline type battery.*

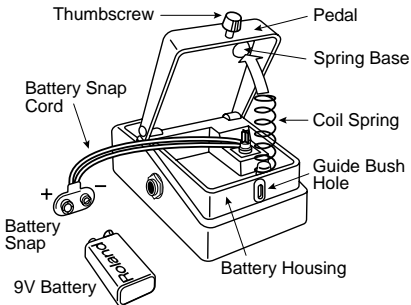

1. Loosen the thumbscrew at the front of the pedal, then lift the pedal upwards to open the unit.
** The thumbscrew can be left in the pedal while changing the battery.*
2. Remove the old battery from the battery housing, and remove the battery snap connected to it.
3. Connect the battery snap to the new battery, and place the battery inside the battery housing.
** Be sure to carefully observe the battery's polarity (+ versus -).*
4. Slip the coil spring onto the spring base on the back of the pedal, then close the pedal.
** Take care not to allow the battery snap cord to become caught in the pedal, coil spring, or other places.*
5. Finally, insert the thumbscrew into the guide bush hole and fasten it securely.

Troubleshooting

Power won't come on/

CHECK indicator doesn't light:

- **Is the specified adaptor (PSA-series; sold separately) properly connected?**
Check the connection once more (p. 10).
- **Is the battery low or dead?**
Replace with a new battery (p. 17).
- **Is the guitar connected properly to the INPUT jack?**
Check the connection once more (p. 10).
 - * *To prevent excess battery drainage, turn the power on without the plug inserted in the INPUT jack.*
 - * *The battery that was supplied with the unit is for temporary use—intended primarily for testing its operation. For using the unit for more extended periods of time, we recommend the use of alkaline batteries.*

No sound / Low volume:

- **Is the PH-3 properly connected to your instrument?**
Check the connection once more (p. 10).
- **Is the volume turned down on any guitar amp or effects device you have connected?**

Sound is distorted:

- **Is the battery low?**
As the battery is drained, the CHECK indicator dims, and the PH-3 may start to function incorrectly. Replace with a new battery (p. 17).
- **Could the level of the sound being input be excessive?**
With some guitars, distortion may be produced. Be careful of your guitar's output level.

Cannot adjust the RATE using (optional) external EV-5 pedal:

- Could the EV-5's minimum volume be set to the maximum level (10)?
- Could the RATE knob be set to MIN?

You cannot input the tempo with the external foot switch:

- Is the connector cord designed for stereo use?
- Have you connected a latch-type foot switch (such as the optional BOSS FS-5L)?

Cannot input the tempo correctly with the external foot switch:

- Is the polarity switch of the foot switch (optional BOSS FS-5U) set correctly?
Check the connection once more (p. 10).

The effect doesn't change:

- Could the RATE knob be set to MIN?
- If the STAGE switch is at a setting other than RISE or FALL, is the DEPTH knob set to MIN?

Setting samples

Vintage Phase Shift 1

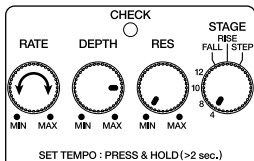

Standard Phase Shift

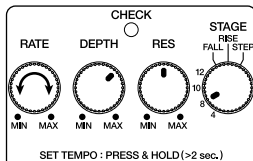

Vintage Phase Shift 2

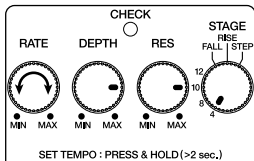

Deep Phase Shift

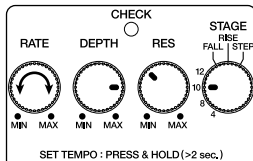

Hard Resonance Sound

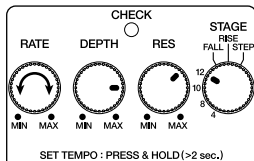

Standard FALL/RISE Sound

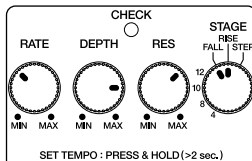

Random Step Sound

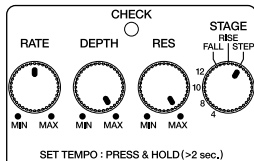

Tremolo Sound

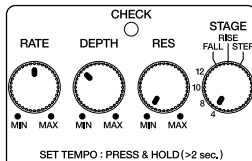

Setting memo

()

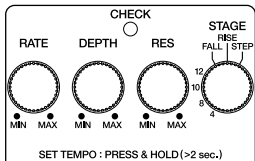

()

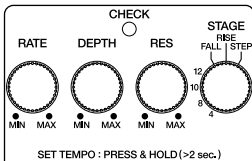

()

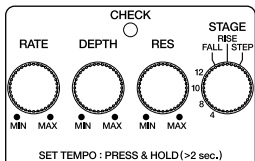

()

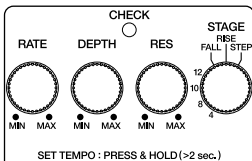

Specifications

PH-3: Phase Shifter

Nominal Input Level	-20 dBu
Input Impedance	1 M Ω
Nominal Output Level	-20 dBu
Output Impedance	1 k Ω
Recommended Load Impedance	10 k Ω or greater
Residual Noise	-92 dBu (IHF-A, Type.)
Controls	Pedal Switch, RATE Knob, DEPTH Knob, RES (resonance) Knob, STAGE Switch
Indicators	CHECK Indicator (Serves also as tempo and battery check indicator)
Connectors	INPUT Jack, OUTPUT Jack, EXP/CTL Jack, AC adaptor Jack
Power Supply	DC 9 V; Dry battery (9 V type) S-006P/9 V (6F22/9 V) Dry battery (9 V type) 6AM6/9 V (alkaline) AC Adaptor (PSA-series: optional)
Current Draw	50 mA (DC 9 V)

* *Expected battery life under continuous use:*

Carbon: 2 hours Alkaline: 6 hours

These figures will vary depending on the actual conditions of use.

Specifications

Dimensions	73 (W) x 129 (D) x 59 (H) mm 2-7/8 (W) x 5-1/8 (D) x 2-3/8 (H) inches
Weight.....	420 g /15 oz (including Battery)
Accessories	Owner's Manual, Leaflet ("USING THE UNIT SAFELY," "IMPORTANT NOTES," and "Information") Dry battery (9 V type) S-006P/9 V (6F22/9 V) <i>* The battery that was supplied with the unit is for temporary use—intended primarily for testing its operation. We recommend that alkaline batteries be used when replacing the batteries.</i>
Options	AC Adaptor (PSA-series) Expression pedal Roland EV-5 Footswitch (momentary-type) BOSS FS-5U Dry battery (9 V type) 6AM6/9 V (alkaline)



* $0 \text{ dBu} = 0.775 \text{ V}_{\text{rms}}$

* *In the interest of product improvement, the specifications and/or appearance of this unit are subject to change without prior notice.*







USING THE UNIT SAFELY

INSTRUCTIONS FOR THE PREVENTION OF FIRE, ELECTRIC SHOCK, OR INJURY TO PERSONS

About WARNING and CAUTION Notices

 WARNING	Used for instructions intended to alert the user to the risk of death or severe injury should the unit be used improperly.
 CAUTION	Used for instructions intended to alert the user to the risk of injury or material damage should the unit be used improperly. * Material damage refers to damage or other adverse effects caused with respect to the home and all its furnishings, as well to domestic animals or pets.

About the Symbols

	The  symbol alerts the user to important instructions or warnings. The specific meaning of the symbol is determined by the design contained within the triangle. In the case of the symbol at left, it is used for general cautions, warnings, or alerts to danger.
	The  symbol alerts the user to items that must never be carried out (are forbidden). The specific thing that must not be done is indicated by the design contained within the circle. In the case of the symbol at left, it means that the unit must never be disassembled.
	The  symbol alerts the user to things that must be carried out. The specific thing that must be done is indicated by the design contained within the circle. In the case of the symbol at left, it means that the power-cord plug must be unplugged from the outlet.

----- **ALWAYS OBSERVE THE FOLLOWING** -----

⚠ WARNING

- Before using this unit, make sure to read the instructions below, and the Owner's Manual.



-
- Do not open (or modify in any way) the unit or its AC adaptor.



-
- Do not attempt to repair the unit, or replace parts within it (except when this manual provides specific instructions directing you to do so). Refer all servicing to your retailer, the nearest Roland Service Center, or an authorized Roland distributor, as listed on the "Information" page.
-



⚠ WARNING

- Never use or store the unit in places that are:



- Subject to temperature extremes (e.g., direct sunlight in an enclosed vehicle, near a heating duct, on top of heat-generating equipment); or are



- Damp (e.g., baths, washrooms, on wet floors); or are
 - Humid; or are
 - Exposed to rain; or are
 - Dusty; or are
 - Subject to high levels of vibration.
-

- Make sure you always have the unit placed so it is level and sure to remain stable. Never place it on stands that could wobble, or on inclined surfaces.
-



 **WARNING**

- Use only the specified AC adaptor (PSA-series), and make sure the line voltage at the installation matches the input voltage specified on the AC adaptor's body. Other AC adaptors may use a different polarity, or be designed for a different voltage, so their use could result in damage, malfunction, or electric shock.



-
- Do not excessively twist or bend the power cord, nor place heavy objects on it. Doing so can damage the cord, producing severed elements and short circuits. Damaged cords are fire and shock hazards!
-



 **WARNING**

- This unit, either alone or in combination with an amplifier and headphones or speakers, may be capable of producing sound levels that could cause permanent hearing loss. Do not operate for a long period of time at a high volume level, or at a level that is uncomfortable. If you experience any hearing loss or ringing in the ears, you should immediately stop using the unit, and consult an audiologist.



-
- Do not allow any objects (e.g., flammable material, coins, pins); or liquids of any kind (water, soft drinks, etc.) to penetrate the unit.
-



 **WARNING**

- Immediately turn the power off, remove the AC adaptor from the outlet, and request servicing by your retailer, the nearest Roland Service Center, or an authorized Roland distributor, as listed on the “Information” page when:
 - The AC adaptor or the power-supply cord has been damaged; or
 - Objects have fallen into, or liquid has been spilled onto the unit; or
 - The unit has been exposed to rain (or otherwise has become wet); or
 - The unit does not appear to operate normally or exhibits a marked change in performance.
-



 **WARNING**

- In households with small children, an adult should provide supervision until the child is capable of following all the rules essential for the safe operation of the unit.
-
- Protect the unit from strong impact. (Do not drop it!)
-
- Do not force the unit's power-supply cord to share an outlet with an unreasonable number of other devices. Be especially careful when using extension cords—the total power used by all devices you have connected to the extension cord's outlet must never exceed the power rating (watts/amperes) for the extension cord. Excessive loads can cause the insulation on the cord to heat up and eventually melt through.
-



WARNING

- Before using the unit in a foreign country, consult with your retailer, the nearest Roland Service Center, or an authorized Roland distributor, as listed on the “Information” page.



- Batteries must never be recharged, heated, taken apart, or thrown into fire or water.



CAUTION

- The unit and the AC adaptor should be located so their location or position does not interfere with their proper ventilation.



- Always grasp only the plug or the body of the AC adaptor when plugging into, or unplugging from, an outlet or this unit.







- Whenever the unit is to remain unused for an extended period of time, disconnect the AC adaptor.





- Try to prevent cords and cables from becoming entangled. Also, all cords and cables should be placed so they are out of the reach of children.



 **CAUTION**

- Never climb on top of, nor place heavy objects on the unit. 
- Never handle the AC adaptor body, or its plugs, with wet hands when plugging into, or unplugging from, an outlet or this unit. 
- Before moving the unit, disconnect the AC adaptor and all cords coming from external devices. 
- Before cleaning the unit, turn off the power and unplug the AC adaptor from the outlet (p. 10). 
- Whenever you suspect the possibility of lightning in your area, disconnect the AC adaptor from the outlet. 

 **CAUTION**

- If used improperly, batteries may explode or leak and cause damage or injury. In the interest of safety, please read and observe the following precautions (p. 17). 
- Carefully follow the installation instructions for batteries, and make sure you observe the correct polarity.
- Avoid using new batteries together with used ones. In addition, avoid mixing different types of batteries.
- Remove the batteries whenever the unit is to remain unused for an extended period of time.



CAUTION

- If a battery has leaked, use a soft piece of cloth or paper towel to wipe all remnants of the discharge from the battery compartment. Then install new batteries. To avoid inflammation of the skin, make sure that none of the battery discharge gets onto your hands or skin. Exercise the utmost caution so that none of the discharge gets near your eyes. Immediately rinse the affected area with running water if any of the discharge has entered the eyes.
 - Never keep batteries together with metallic objects such as ballpoint pens, necklaces, hairpins, etc.
-



CAUTION

- Used batteries must be disposed of in compliance with whatever regulations for their safe disposal that may be observed in the region in which you live.
-
- Should you remove the Thumb-screw, make sure to put them in a safe place out of children's reach, so there is no chance of them being swallowed accidentally.
-





This product complies with the requirements of European Directive 89/336/EEC.

For EU Countries

FEDERAL COMMUNICATIONS COMMISSION RADIO FREQUENCY INTERFERENCE STATEMENT

For the USA

This equipment has been tested and found to comply with the limits for a Class B digital device, pursuant to Part 15 of the FCC Rules. These limits are designed to provide reasonable protection against harmful interference in a residential installation. This equipment generates, uses, and can radiate radio frequency energy and, if not installed and used in accordance with the instructions, may cause harmful interference to radio communications. However, there is no guarantee that interference will not occur in a particular installation. If this equipment does cause harmful interference to radio or television reception, which can be determined by turning the equipment off and on, the user is encouraged to try to correct the interference by one or more of the following measures:

- Reorient or relocate the receiving antenna.
- Increase the separation between the equipment and receiver.
- Connect the equipment into an outlet on a circuit different from that to which the receiver is connected.
- Consult the dealer or an experienced radio/TV technician for help.

This device complies with Part 15 of the FCC Rules. Operation is subject to the following two conditions:

- (1) This device may not cause harmful interference, and
- (2) This device must accept any interference received, including interference that may cause undesired operation.

Unauthorized changes or modification to this system can void the users authority to operate this equipment.
This equipment requires shielded interface cables in order to meet FCC class B Limit.

For Canada

NOTICE

This Class B digital apparatus meets all requirements of the Canadian Interference-Causing Equipment Regulations.

AVIS

Cet appareil numérique de la classe B respecte toutes les exigences du Règlement sur le matériel brouilleur du Canada.