

TASCAM

042100800

Model 12

Multitrack Recording Console

OWNER'S MANUAL

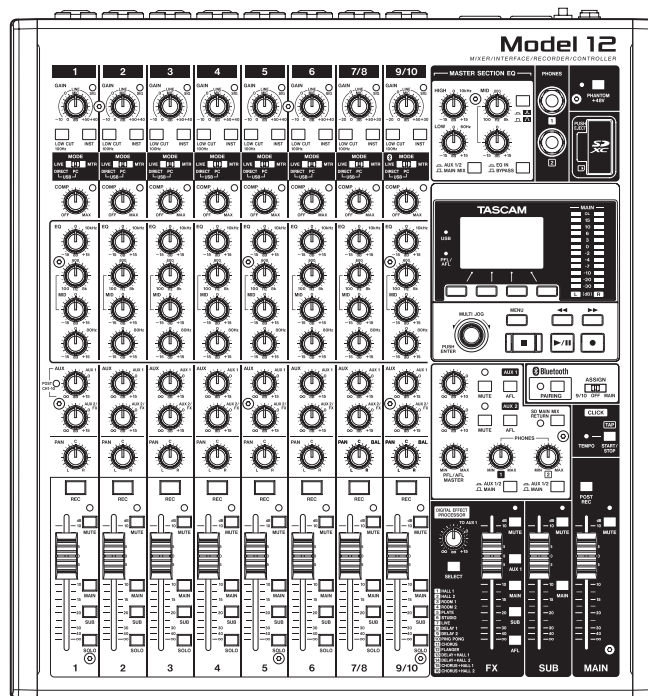

IMPORTANT SAFETY INSTRUCTIONS

WARNING: TO PREVENT FIRE OR SHOCK HAZARD, DO NOT EXPOSE THIS APPLIANCE TO RAIN OR MOISTURE.

For U.S.A.

Declaration of Conformity

Model Number: Model 12

Trade Name: TASCAM

Responsible party: TEAC AMERICA, INC.

Address: 10410 Pioneer Blvd. Suite #1 Santa Fe Springs,
California 90670, U.S.A.

Telephone number: 1-323-726-0303



This device complies with Part 15 of the FCC Rules. Operation is subject to the following two conditions: (1) this device may not cause harmful interference, and (2) this device must accept any interference received, including interference that may cause undesired operation.

INFORMATION TO THE USER

This equipment has been tested and found to comply with the limits for a Class B digital device, pursuant to Part 15 of the FCC Rules. These limits are designed to provide reasonable protection against harmful interference in a residential installation. This equipment generates, uses, and can radiate radio frequency energy and, if not installed and used in accordance with the instruction manual, may cause harmful interference to radio communications. However, there is no guarantee that interference will not occur in a particular installation. If this equipment does cause harmful interference to radio or television reception, which can be determined by turning the equipment off and on, the user is encouraged to try to correct the interference by one or more of the following measures.

- Reorient or relocate the receiving antenna.
- Increase the separation between the equipment and receiver.
- Connect the equipment into an outlet on a circuit different from that to which the receiver is connected.
- Consult the dealer or an experienced radio/TV technician for help.

CAUTION

Changes or modifications to this equipment not expressly approved by TEAC CORPORATION for compliance could void the user's authority to operate this equipment.

For Canada

THIS CLASS B DIGITAL APPARATUS COMPLIES WITH CANADIAN ICES-003.

CET APPAREIL NUMERIQUE DE LA CLASSE B EST CONFORME A LA NORME NMB-003 DU CANADA.



This product complies with the European Directives request and the other Commission Regulations.

- Read these instructions.
- Keep these instructions.
- Heed all warnings.
- Follow all instructions.
- Do not use this apparatus near water.
- Clean only with dry cloth.
- Do not block any ventilation openings. Install in accordance with the manufacturer's instructions.
- Do not install near any heat sources such as radiators, heat registers, stoves, or other apparatus (including amplifiers) that produce heat.
- Do not defeat the safety purpose of the polarized or grounding-type plug. A polarized plug has two blades with one wider than the other. A grounding type plug has two blades and a third grounding prong. The wide blade or the third prong are provided for your safety. If the provided plug does not fit into your outlet, consult an electrician for replacement of the obsolete outlet.
- Protect the power cord from being walked on or pinched particularly at plugs, convenience receptacles, and the point where they exit from the apparatus.
- Only use attachments/accessories specified by the manufacturer.
- Use only with the cart, stand, tripod, bracket, or table specified by the manufacturer, or sold with the apparatus. When a cart is used, use caution when moving the cart/apparatus combination to avoid injury from tip-over.



- Unplug this apparatus during lightning storms or when unused for long periods of time.
 - Refer all servicing to qualified service personnel. Servicing is required when the apparatus has been damaged in any way, such as power-supply cord or plug is damaged, liquid has been spilled or objects have fallen into the apparatus, the apparatus has been exposed to rain or moisture, does not operate normally, or has been dropped.
- The apparatus draws nominal non-operating power from the AC outlet with its POWER or STANDBY/ON switch not in the ON position.
 - The mains plug is used as the disconnect device, the disconnect device shall remain readily operable.
 - Caution should be taken when using earphones or headphones with the product because excessive sound pressure (volume) from earphones or headphones can cause hearing loss.
 - If you are experiencing problems with this product, contact TEAC for a service referral. Do not use the product until it has been repaired.

IMPORTANT SAFETY INSTRUCTIONS

WARNING

- To prevent possible hearing damage, do not listen at high volume levels for long periods.



CAUTION

- Do not expose this apparatus to drips or splashes.
- Do not place any objects filled with liquids, such as vases, on the apparatus.
- Do not install this apparatus in a confined space such as a book case or similar unit.
- The apparatus should be located close enough to the AC outlet so that you can easily grasp the power cord plug at any time.
- If the product uses batteries (including a battery pack or installed batteries), they should not be exposed to sunshine, fire or excessive heat.
- CAUTION for products that use replaceable lithium batteries: there is danger of explosion if a battery is replaced with an incorrect type of battery. Replace only with the same or equivalent type.

For European Customers

Disposal of electrical and electronic equipment and batteries and/or accumulators

- (a) All electrical/electronic equipment and waste batteries/accumulators should be disposed of separately from the municipal waste stream via collection facilities designated by the government or local authorities.
- (b) By disposing of electrical/electronic equipment and waste batteries/accumulators correctly, you will help save valuable resources and prevent any potential negative effects on human health and the environment.
- (c) Improper disposal of waste electrical/electronic equipment and batteries/accumulators can have serious effects on the environment and human health because of the presence of hazardous substances in the equipment.
- (d) The Waste Electrical and Electronic Equipment (WEEE) symbols, which show wheeled bins that have been crossed out, indicate that electrical/electronic equipment and batteries/accumulators must be collected and disposed of separately from household waste.



If a battery or accumulator contains more than the specified values of lead (Pb), mercury (Hg), and/or cadmium (Cd) as defined in the Battery Directive (2006/66/EC, 2013/56/EU), then the chemical symbols for those elements will be indicated beneath the WEEE symbol.



Pb, Hg, Cd

- (e) Return and collection systems are available to end users. For more detailed information about the disposal of old electrical/electronic equipment and waste batteries/accumulators, please contact your city office, waste disposal service or the shop where you purchased the equipment.

IMPORTANT SAFETY INSTRUCTIONS

For China

 “仅适用于海拔2000m以下地区安全使用”

 “仅适用于非热带气候条件下安全使用”

 “环境保护使用年限”

产品有毒有害物质或元素的名称及含量

机种: Model 12		有毒有害物质或元素					
	品名	铅 (Pb)	汞 (Hg)	镉 (Cd)	六价铬 (Cr6+)	多溴联苯 (PBB)	多溴二苯醚 (PBDE)
1	CHASSIS部份	○	○	○	○	○	○
2	FRONT PANEL部份	○	○	○	○	○	○
3	螺丝部份	○	○	○	○	○	○
4	线材部份	○	○	○	○	○	○
5	PCB Assy部份	×	○	○	○	○	○
6	电源部份	×	○	○	○	○	○
7	附属品部份	×	○	○	○	○	○
8	LABEL部份	○	○	○	○	○	○
9	包装部份	○	○	○	○	○	○

○ : 表示该有毒有害物质在该部件所有均质材料中的含量均在 GB/T26572 标准规定的限量要求以下。

× : 表示该有毒有害物质至少在该部件的某一均质材料中的含量超出 GB/T26572标准规定的限量要求。

(针对现在代替技术困难的电子部品及合金中的铅)

Wireless equipment precautions

Compliance of radio transmitter and interference

This product has the function of broadband transmitter using 2.4GHz Band.

Use frequency range: 2400 MHz - 2480 MHz

Maximum output power: Bluetooth® Class 2 (less than 2.5 mW) Please use only in the country where you purchased the product. Depending on the country, restrictions on the use of Bluetooth wireless technology might exist.

Model for USA

Declaration of Conformity

Responsible party: TEAC AMERICA, INC.
Address: 10410 Pioneer Blvd. Suite #1 Santa Fe Springs, California 90670, U.S.A.
Telephone number: 1-323-726-0303



This device complies with Part.15 of FCC Rules. Operation is subject to the following two conditions: (1) this device may not cause harmful interference, and (2) this device must accept any interference received, including interference that may cause undesired operation.

Labeling of authorization

FCC ID: XEG-MODEL12

Model for Canada

Compliance of radio transmitter

This device complies with Industry Canada's licence-exempt RSSs.

Operation is subject to the following two conditions:

- 1) This device may not cause interference
- 2) This device must accept any interference, including interference that may cause undesired operation of the device.

Labeling of authorization

IC: 1559C-MODEL12

Modèle pour le Canada

Conformité de l'émetteur radio

Ce dispositif est conforme à la norme CNR-210 d'Industrie Canada applicable aux appareils radio exempts de licence. Son fonctionnement est sujet aux deux conditions suivantes:

- 1) Le dispositif ne doit pas produire de brouillage préjudiciable, et
- 2) Ce dispositif doit accepter tout brouillage reçu, y compris un brouillage susceptible de provoquer un fonctionnement indésirable.

Étiquetage d'autorisation

IC: 1559C-MODEL12

Compliance of interference

This Class B digital apparatus complies with Canadian ICES-003.

This equipment complies with FCC/IC radiation exposure limits set forth for an uncontrolled environment and meets the FCC radio frequency (RF) Exposure Guidelines and RSS-102 of the IC radio frequency (RF) Exposure rules. This equipment has very low levels of RF energy that it deemed to comply without maximum permissive exposure evaluation (MPE). But it is desirable that it should be installed and operated keeping the radiator at least 20 cm or more away from person's body (excluding extremities: hands, wrists, feet and ankles).

Cet équipement est conforme aux limites d'exposition aux rayonnements énoncées pour un environnement non contrôlé et respecte les règles les radioélectriques (RF) de la FCC lignes directrices d'exposition et d'exposition aux fréquences radioélectriques (RF) CNR-102 de l'IC. Cet équipement émet une énergie RF très faible qui est considérée conforme sans évaluation de l'exposition maximale autorisée. Cependant, cet équipement doit être installé et utilisé en gardant une distance de 20 cm ou plus entre le dispositif rayonnant et le corps (à l'exception des extrémités : mains, poignets, pieds et chevilles).

Conformité de brouillage

Cet appareil numérique de la classe B est conforme à la norme NMB-003 du Canada.

Marquage d'autorisation

CAN ICES-3(B)/NMB-3(B)

Model for EEA (European Economic Area)



Hereby, TEAC Corporation declares that the radio equipment type is in compliance with Directive 2014/53/EU, and the other Directives, and Commission Regulations.

The full text of the EU declaration of conformity is available at the following internet address: Please contact us by e-mail.

<http://tascam.eu/en/kontakt.html>

EU Importer: TEAC Europe GmbH

Bahnstrasse 12, 65205 Wiesbaden-Erbenheim, Germany

Radiation Exposure requirements

This equipment meets the regulation, which is recognized internationally, for the case of human exposure to radio waves generated by the transmitter.

Statement of compliance

Model for USA

This equipment complies with FCC radiation exposure limits set forth for an uncontrolled environment and meets the FCC radio frequency Exposure Guidelines.

Model for Canada

This equipment complies with IC RSS-102 radiation exposure limits set forth for an uncontrolled environment.

Model for USA/Canada

This Class B digital apparatus complies with Canadian ICES-003. This equipment complies with FCC/IC radiation exposure limits set forth for an uncontrolled environment and meets the FCC radio frequency (RF) Exposure Guidelines and RSS-102 of the IC radio frequency (RF) Exposure rules. This equipment has very low levels of RF energy that it deemed to comply without maximum permissive exposure evaluation (MPE). But it is desirable that it should be installed and operated keeping the radiator at least 20 cm or more away from person's body (excluding extremities: hands, wrists, feet and ankles).

Model for EEA (European Economic Area)

This equipment complies with EN.62311; Assessment of electronic and electrical equipment related to human exposure restrictions for electromagnetic fields; the harmonised standard of DIRECTIVE 2014/53/EU.

Contents

IMPORTANT SAFETY INSTRUCTIONS	2	4 - Managing Songs	27
Wireless equipment precautions	5	Viewing the song list	27
1 - Introduction	8	Song Operation	27
Features	8	Creating a New Song	27
Items included with this product	8	Loading Songs	28
Conventions used in this manual	8	Saving the current song	28
Trademarks	9	Viewing song information	28
Precautions for placement and use	9	Clearing all marks	28
Beware of condensation	9	Deleting songs	28
Cleaning the unit	9	Protecting/unprotecting songs	29
About SD cards	10	Editing song names	29
Precautions for use	10	Editing text	29
SD card write protection	10	Loading songs created on different TASCAM Model series products	30
Note about formatting	10	5 - Basic recording	31
Bluetooth®	10	Selecting the input source	31
Profiles	10	Setting the MODE switch	31
Codecs	10	Setting phantom power	31
Content protection	10	Monitoring	31
Transmission security	10	SIG indicators and level meters	32
Using the TEAC Global Site	11	Recording	32
Product registration	11	Undoing operations	33
About TASCAM customer support service	11	Undoing the previous operation	33
2 - Names and Functions of Parts	12	Using the built-in effects	33
Top panel	12	Setting the built-in effect	33
Input channel mixing section-1	12	Using the library	34
Input channel mixing section-2	13	6 - Recorder functions	35
Equalizer section	14	Locate function	35
Screen operation section	14	Changing the playback position	35
Monitoring section	15	Using the direct locate function to locate	35
Analog output adjustment section	16	Repeat playback function	35
Rear panel	17	Punch in/out function	35
Home Screen	18	Using the footswitch to punch in/out	35
Meters Screen	19	Automatic punch in/out function	36
Meter Screen details	19	Setting the punch in/out points	36
Menu structure	20	Setting a pre roll point	36
Basic MENU screen operations	21	Rehearsing punching in and out	36
Menu operation procedures	21	Using automatic punching in and out	37
3 - Preparation	22	7 - Track editing	38
Connecting the power supply and other equipment	22	Clearing tracks	38
Connecting the power	23	Importing tracks	38
Connecting microphones	23	Swapping tracks	39
Connecting guitars, basses and similar instruments	23	Stereo mix export function	39
Connecting electronic devices and other audio equipment	23	8 - Mark functions	40
Connecting smartphones/portable audio players	23	Using mark functions	40
Connecting monitor speakers	23	Adding marks	40
Connecting headphones	23	Moving between marks	40
Connecting a computer	23	Clearing individual marks	40
Connecting with Bluetooth devices	24	9 - Other functions	41
Inserting and removing SD cards	24	Metronome functions	41
Inserting SD cards	24	Setting the click sound	41
Removing SD cards	24	Making metronome settings	42
SD card write protection switches	24	Setting the count in function	43
Turning the power on and off	24	Starting and stopping the metronome manually	43
Setting the built-in clock date and time	25	Function button setting	43
Adjusting the display	26	MIDI functions	44
Adjusting the display contrast	26	Setting MIDI time code operation	44
Adjusting the display brightness	26	Setting MIDI CLOCK/SPP	44
Preparing an SD card for use	26	Mixer functions	45
		Selecting the positions that recording signals are sent from each channel	45

Setting the phase of each channel	45
Changing the positions that signals are sent to the AUX 1 bus from each channel.....	46
Setting the solo function for all channels	46
Footswitch functions	47
Setting up the footswitch	47
Setting the footswitch polarity	47
DAW CONTROL.....	47
10 - Settings and Information.....	48
Viewing information	48
CARD Screen	48
SONG Screen.....	48
FIRMWARE Screen	48
Setting the song name format	48
Setting the WORD item.....	48
Restoring factory default settings.....	49
Formatting SD cards.....	49
Playing WAV files on SD cards (SD PLAY mode).....	50
11 - Using a computer to transfer data	51
Connecting with a Computer	51
Disconnecting	52
Loading WAV files from a computer	52
12 - USB audio interface functions.....	53
Installing the dedicated software	53
Installing the Windows dedicated software	53
Installing the Mac dedicated software.....	54
Working with Gatekeeper	54
Uninstalling the dedicated software.....	55
Uninstalling the Windows dedicated software	55
Uninstalling the Mac dedicated software	55
Opening the Settings Panel.....	55
Windows.....	55
Mac	55
Settings Panel overview.....	56
Notification function.....	56
Setting Sound Properties	56
Simultaneous ASIO/WDM playback	57
USB audio mode.....	57
13 - MIDI Implementation Chart.....	58
14 - Messages.....	59
15 - Troubleshooting	61
16 - Specifications.....	62
General.....	62
Inputs and outputs	62
Analog audio input and output ratings	62
Control input/output	62
Computer system requirements.....	63
Windows.....	63
Mac	63
iOS device	63
Supported audio drivers.....	63
Audio performance	63
Bluetooth	64
Other.....	64
Dimensional drawings.....	64
Block diagram.....	65
Level diagram	66

1 - Introduction

Thank you very much for purchasing the TASCAM Model 12 Multitrack Recording Console.

Before using this unit, read this Owner's Manual carefully so that you will be able to use it correctly and enjoy working with it for many years. After you have finished reading this manual, please keep it in a safe place for future reference.

You can also download this Owner's Manual from the TEAC Global Site (<http://teac-global.com/>).

Features

- TASCAM Ultra-HDDA mic preamps built-in (for channels 1–6)
- 10 input digital mixer with 10 line and 8 mic inputs
- Multitrack recording and playback with 12-track recording (input channels 1–6, 7/8, 9/10 and MAIN MIX L/R bus channels 11–12)
- USB audio interface functions built-in
 - 12 tracks (10 input channels and MAIN MIX L/R bus) can be input to the computer
 - 10 track outputs and computer outputs can be assigned to channel inputs (channels 1–6, 7/8, 9/10)
 - Supports USB 2.0 audio with resolutions up to 24-bit and 48kHz sampling frequency
- Digital compressors included on channel 1–6, 7/8 and 9/10 inputs
- 60mm faders enable precise adjustments
- MIC/LINE (BAL)/INST TRS input jacks support high impedance (Hi-Z) on every channel
- Channel inserts (INSERT) on channels 1-2
- Multiple buses include stereo main (MAIN MIX L/R bus), sub (SUB L/R bus) and AUX (AUX 1 and AUX 2/FX)
- 2 AUX sends (AUX 1/AUX 2)
- Input channels have 3-band semi-parametric EQs with adjustable mid frequencies
- 4-band semi-parametric equalizer for output
- 16 TASCAM preset effects can be used for a variety of applications
- Multitrack recording and playback possible using SD cards
- Bluetooth® audio playback and recording supported
- Punching in and out function per track (including punching in and out automatically and with footswitches)
- SD/SDHC cards and SDXC cards (Class 10 or more)
- Multiple footswitch functions available (select play/pause, effect muting or punch in/out)
- 2 built-in PHONES outputs (level adjustment and SOLO L/R bus monitoring can be enabled separately)
- DAW control with HUI/MCU emulation supported by major DAWs
- CLICK output that supports TAP TEMPO
- MIDI input and output connectors enable connection with keyboards and other MIDI devices

Items included with this product

This product includes the following items.

Take care when opening the package to avoid damaging the items. Keep the packing materials for transportation in the future. Please contact the store where you purchased this unit if any of these items are missing or have been damaged during transportation.

- Main unit x 1
- AC adaptor (TASCAM PS-M1524A)..... x 1
- Cord for AC adapter (JAPAN USA/EUROPE/AUSTRALIA) x 3
- Owner's Manual (this document) including warranty x 1

ATTENTION

Always use the included AC adapter (PS-M1524A) and AC adapter power cord with this unit. Never use the included AC adapter or AC power cord with any other device. Doing so could cause damage, fire or electric shock.

Conventions used in this manual

In this manual, we use the following conventions:

- The four buttons under the display are called the function buttons. From left to right, they are shown as buttons **F1**, **F2**, **F3** and **F4**. Moreover, the functions at the bottoms of the screens will be shown after the button names.
Examples: **F1** **METR** button, **F4** **MARK** button
- SD/SDHC/SDXC memory cards are referred to as "SD cards".
- Computers, portable audio devices and other equipment connected to this unit using Bluetooth are called "Bluetooth devices".
- Groups of recorded data are referred to as "songs".
- The song that is currently selected is called the "current song".
- Information shown on a computer display is written like this: "OK".
- As necessary, additional information is provided under TIP, NOTE and CAUTION headings.

TIP

These are tips about how to use the unit.

NOTE

These provide additional explanations and describe special cases.

ATTENTION

Failure to follow these instructions could result in damage to equipment or lost data, for example.

CAUTION

Failure to follow these instructions could result in injury.

Trademarks

- TASCAM is a registered trademark of TEAC Corporation.
- SDXC Logo is a trademark of SD-3C, LLC.



- The Bluetooth® word mark and logo are the property of Bluetooth SIG, Inc. and are used by TEAC Corporation with permission.
- Microsoft, Windows and Windows Media are either registered trademarks or trademarks of Microsoft Corporation in the United States and/or other countries.
- Apple, Mac, macOS, App Store and iTunes are trademarks of Apple Inc. in the United States and other countries.
- ASIO is a trademark of Steinberg Media Technologies GmbH.



- Other company names, product names and logos in this document are the trademarks or registered trademarks of their respective owners.

Information is given about products in this manual only for the purpose of example and does not indicate any guarantees against infringements of third-party intellectual property rights and other rights related to them. TEAC Corporation will bear no responsibility for infringements on third-party intellectual property rights or their occurrence because of the use of these products.

Properties copyrighted by third parties cannot be used for any purpose other than personal enjoyment and the like without the permission of the right holders recognized by copyright law. Always use this equipment properly. TEAC Corporation will bear no responsibility for rights infringements committed by users of this product.

Precautions for placement and use

- The operating temperature range of this unit is 5 - 35 °C.
- Do not install this unit in the following types of locations. Doing so could make the sound quality worse or cause malfunction.
 - Places with significant vibrations
 - Next to a window or in another location exposed to direct sunlight
 - Near heaters or other extremely hot places
 - Extremely cold places
 - Very humid or poorly ventilated places
 - Very dusty places
- To enable good heat dissipation, do not place anything on top of the unit.
- Do not place the unit on top of a power amplifier or other device that generates heat.

Beware of condensation

Condensation could occur if the unit is moved from a cold place to a warm place, it is used immediately after a cold room has been heated or it is otherwise exposed to a sudden temperature change.

To prevent this, or if this occurs, let the unit sit for one or two hours at the new room temperature before using it.

Cleaning the unit

Use a dry soft cloth to wipe the unit clean. Do not wipe with chemical cleaning cloths, thinner, alcohol or other chemical agents. Doing so could damage the surface or cause discoloration.

1 - Introduction

About SD cards

This unit uses SD cards for recording and playback.

This unit can use SD cards that are Class 10 or higher and compatible with SD, SDHC or SDXC standards.

A list of SD cards that have been confirmed for use with this unit can be found on our web site. Please access to a product page of this product from the TEAC Global Site (<http://teac-global.com>) to find the list or contact the TASCAM customer support service.

Precautions for use

SD cards are delicate media.

In order to avoid damaging SD cards, please take the following precautions when handling them.

- Do not leave them in extremely hot or cold places.
- Do not leave them in extremely humid places.
- Do not let them get wet.
- Do not put things on top of them or twist them.
- Do not hit them.
- Do not remove or insert them during recording, playback, data transmission or other access.
- When transporting them, put them into cases, for example.

SD card write protection

This unit writes track information to the media in order to improve operation performance. Since, for example, setting information cannot be written to SD cards that are writeprotected, settings will not be retained when the unit is restarted and performance will be otherwise affected.

Note about formatting

SD cards formatted by this unit are optimized to improve performance during recording. Use this unit to format the SD cards to be used with it. Errors might occur when recording with this unit using an SD card formatted by a computer or other device.

Bluetooth®

This unit has a built-in Bluetooth audio receiver, and can input sound played on a computer or portable audio device that supports Bluetooth (Bluetooth device).

ATTENTION

The Bluetooth function of this unit is not guaranteed to enable connection or operation with all Bluetooth devices.

Profiles

This unit supports the following Bluetooth profiles.

- A2DP (Advanced Audio Distribution Profile)

In order to transfer audio by Bluetooth, the Bluetooth device must support A2DP.

Even if a Bluetooth device supports the same profiles, though, its functions might differ according to its specifications.

Codecs

This unit supports the following codecs. It will automatically select one of them during audio transfer.

- SBC
- AAC

The unit will select the appropriate codec to use according to the codec compatibility of the other Bluetooth device and communication conditions.

NOTE

- You cannot select the codec to be used by pressing a button, for example.
- Due to characteristics of Bluetooth wireless technology, playback from this unit will be slightly delayed compared to playback from the Bluetooth device.

Content protection

This unit supports SCMS-T as a form of content protection when transmitting audio, so it can play protected audio.

Transmission security

This unit supports security functions during Bluetooth transmission in accordance with the Bluetooth standard specifications, but it does not guarantee the privacy of such transmissions.

TEAC CORPORATION will bear no responsibility should an information leak occur during transmission by Bluetooth.

Using the TEAC Global Site

You can download updates for this unit from the TEAC Global Site:

<http://teac-global.com/>

In the TASCAM Downloads section, select the desired language to open the Downloads website page for that language.

Product registration

Customers in the USA, please visit the following TASCAM website to register your TASCAM product online.

<https://tascam.com/us/>

About TASCAM customer support service

TASCAM products are supported and warranted only in their country/region of purchase.

To receive support after purchase, on the TASCAM Distributors list page of the TEAC Global Site (<http://teac-global.com/>), search for the local company or representative for the region where you purchased the product and contact that organization.

When making inquiries, the address (URL) of the shop or web shop where it was purchased and the purchase date are required.

Moreover, the warranty card and proof of purchase might also be necessary.

2 - Names and Functions of Parts

Top panel

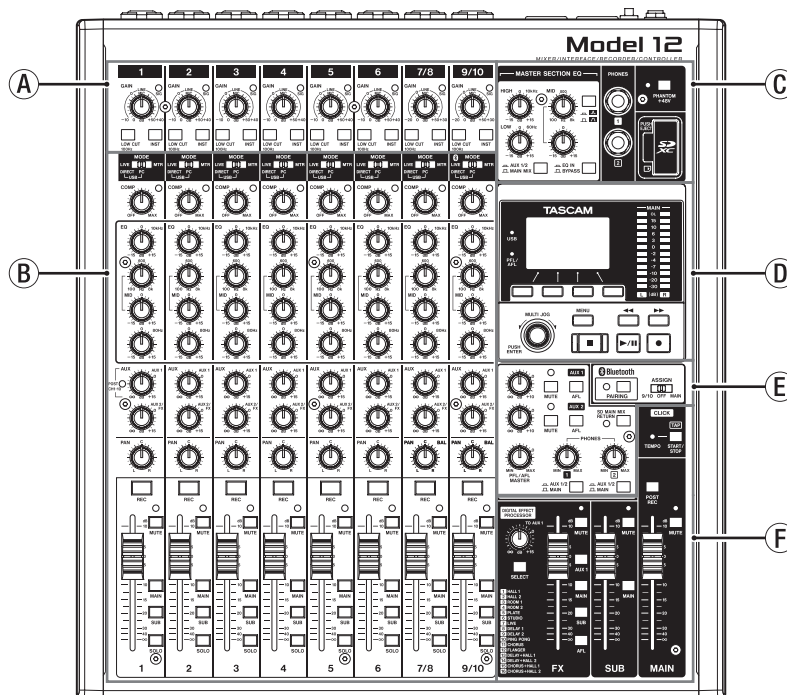

A Input channel mixing section-1

Use this section to adjust the input levels of each channel.

B Input channel mixing section-2

Use this section to choose input sources for each channel, adjust compressors and equalizers, and set levels sent to each bus (MAIN MIX L/R, SOLO L/R, AUX1, AUX2/FX, SUB L/R). (see "Input channel mixing section-2" on page 13)

C Equalizer section

Use this section to connect headphones and adjust the output equalizer. (see "Equalizer section" on page 14)

D Screen operation section

Use this section to operate the meter, home and MENU screens on the display. (see "Screen operation section" on page 14)

E Monitoring section

Switch Bluetooth device input destinations, switch monitoring destinations, and adjust AUX OUTPUT AUX 1/2 jack output levels. (see "Monitoring section" on page 15)

F Analog output adjustment section

Adjust the output levels of the built-in effects, and the MAIN OUTPUT and SUB OUTPUT jacks. (see "Analog output adjustment section" on page 16)

Input channel mixing section-1

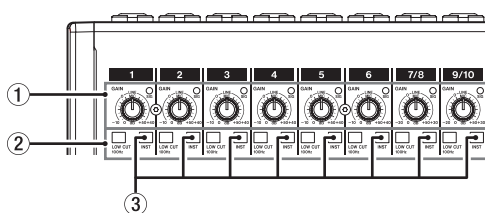

1 GAIN knobs and SIG indicators (1-6, 7/8-9/10)

Use the GAIN knobs to adjust the input levels of each channel.
its SIG indicator will light green when a signal is input (-40dB or higher).
If a SIG indicator stays lit red continuously, lower the GAIN knob.

2 LOW CUT switches (1-6, 7/8-9/10)

Turn this switch on (pushed in) to enable low cut filters that cut noise and other sounds at low frequencies.

3 INST switches (1-6, 7/8-9/10)

Set according to the MIC/LINE (BAL)/INST TRS input jack input sources.

Turn the INST switch on (pushed in) when connecting a guitar, bass or other equipment with high output impedance.
Turn the INST switch off (not pushed in) when connecting electronic instruments, audio devices, mics and other equipment.

Input channel mixing section-2

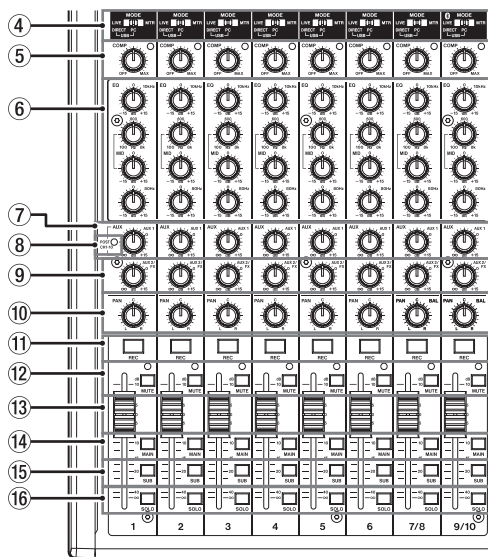

- ④ **MODE switches (1-6, 7/8-9/10)**
Use these to select the input source for each channel. (see "Setting the MODE switch" on page 31)
- ⑤ **COMP knobs and indicators (1-6, 7/8-9/10)**
Use these knobs to adjust the compression thresholds for the signals input to each channel.
When compression is activated, the COMP indicators light.
- ⑥ **EQ knobs (1-6, 7/8-9/10)**
- Use these to boost and attenuate the HIGH, MID and LOW bands of each channel.
Setting range: ± 15 dB
 - The central frequencies of the MID bands can be set.
Setting range: 100 Hz - 8 kHz (default: 600Hz)
- ⑦ **AUX 1 knobs (1-6, 7/8-9/10)**
Use these to adjust the levels of signals sent to the AUX 1 bus.
- ⑧ **POST indicator (shared by all channels)**
When this indicator is lit, signals are sent to the AUX 1 bus after the channel faders. (see "Changing the positions that signals are sent to the AUX 1 bus from each channel" on page 46)
- ⑨ **AUX2/FX knobs (1-6, 7/8-9/10)**
Use to adjust the levels of the signals sent to the AUX2/FX bus.
- ⑩ **PAN knobs (1-6, 7/8-9/10)**
Use to adjust the stereo positions of the signals input to each channel.

NOTE

- When PAN knobs are centered (C), signals are reduced by 3 dB and sent to both left and right MAIN MIX L/R buses.
- When a PAN knob is turned all the way to the left (L), that channel signal is sent only to the left MAIN MIX L/R bus. It is not sent to the right bus.
- When a PAN knob is turned all the way to the right (R), that channel signal is sent only to the right MAIN MIX L/R bus. It is not sent to the left bus.

- ⑪ **REC buttons and indicators (1-6, 7/8-9/10)**
Use these to select the channels to record to the SD card.
- ⑫ **MUTE switches and indicators (1-6, 7/8-9/10)**
When these switches are on (pushed in, MUTE indicator lit), those channels are muted.
- ⑬ **Channel faders (1-6, 7/8-9/10)**
Use these to adjust the send levels of channel signals.
- ⑭ **MAIN switches (1-6, 7/8-9/10)**
Turn these switches on (pushed in) to send channel signals to the MAIN MIX L/R bus.
- ⑮ **SUB switches (1-6, 7/8-9/10)**
Turn these switches on (pushed in) to send channel signals to the SUB L/R bus.
- ⑯ **SOLO switches (1-6, 7/8-9/10)**
Turn these switches on (pushed in) to send channel signals to the SOLO L/R bus.
When these switches are on, the sound of their channels can be heard through the SOLO L/R bus with headphones.
When the SOLO MODE screen setting is INPLACE SOLO, the signals of channels that are not on will be muted. (see "Setting the solo function for all channels" on page 46)

2 - Names and Functions of Parts

Equalizer section

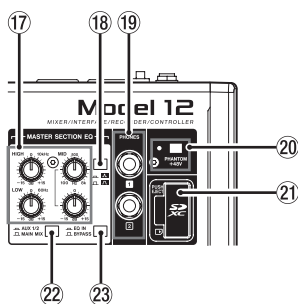



17 MASTER SECTION EQ knobs

This 3-band semi-parametric equalizer affects signals output from the MAIN OUTPUT and AUX OUTPUT AUX 1/2 jacks.

18 / switch

This sets the acuteness of the MID band of the semi-parametric equalizer.

Button	Meaning
On ()	The band is acute, making it affect a narrower frequency band.
Off ()	The band is less acute, making it affect a broader frequency band.

19 PHONES jack (1/2)

Use this standard stereo jack to connect stereo headphones. Use an adapter to connect headphones with a mini plug. Use these to monitor signals from the MAIN MIX L/R, AUX 1, AUX 2/FX and SOLO L/R buses. (see "Block diagram" on page 65)

20 PHANTOM +48V switch and indicator

Use this switch to supply +48V phantom power to the 1–6, 7/8 and 9/10 XLR jacks on the back of the unit. The indicator lights when the PHANTOM +48V switch is set to on (pushed in). (see "Setting phantom power" on page 31)

21 SD card slot

Insert SD cards in this slot. (see "Inserting and removing SD cards" on page 24)

22 AUX 1/2/MAIN MIX switch

Set which output signals are affected by the equalizer.

AUX 1/2: Equalizer is applied to signals sent from the AUX 1 and AUX 2/FX buses.

MAIN MIX: Equalizer is applied to signals sent from the MAIN MIX L/R bus.

NOTE

Also set the EQ IN/BYPASS switch to "EQ IN".

23 EQ IN/BYPASS switch

When this switch is EQ IN, the equalizer will affect the output signals set with the AUX 1/2/MAIN MIX switch.

When set to BYPASS, the equalizer will not be applied regardless of the AUX 1/2/MAIN MIX switch setting.

Screen operation section

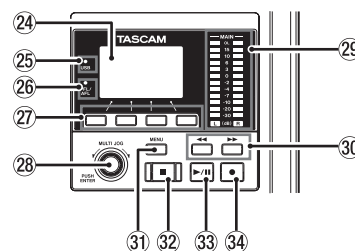

24 Display

Shows a variety of information.

25 USB indicator

This lights when the USB connection is working.

26 PFL/AFL indicator

This indicator lights when at least one channel SOLO switch is on or when the AFL switch for the AUX 1 or AUX 2 knob or the FX fader is on.

27 Function buttons

The functions of these buttons change depending on the screen shown on the display. The functions shown at the bottom of the display are the currently assigned functions.

NOTE

For convenience, the four buttons under the display are called the function buttons in this manual. From left to right, they are called the **F1**, **F2**, **F3** and **F4** buttons.

28 MULTI JOG dial

This dial functions as a dial when turned and as a button when pressed.

Dial functions

- Turn when the Home Screen is open to move the file playback position. (see "Locate function" on page 35)
- When a MENU Screen is open, turn to select items and change setting values. (see "Basic MENU screen operations" on page 21)

Button function

- Press when the Home Screen is open to designate a locate point. (see "Locate function" on page 35)
- When a Menu Screen is open, press to confirm selections and settings (ENTER button function).

29 Output level indicators

These show the output levels of the MAIN OUTPUT jacks. When the PFL/AFL indicator is lit, these show the output levels from the SOLO L/R bus.

2 - Names and Functions of Parts

30 ◀◀/▶▶ buttons

- When stopped and during playback, press and hold these buttons to search backward/forward.
- When the Home Screen is open, press the ◀◀ button to locate to the beginning of the current song (00:00:00, which is the zero point).
- When the Home Screen is open, press the ▶▶ button to locate to the end of the current song.
- If the current song has auto punch in or out points set, you can also locate to those points.
- If the current song has marks set, these can also be used to locate to them.
- While pressing the ■ button, press the ◀◀ button to locate to the point where recording last started.
- While pressing the ■ button, press the ▶▶ button to locate to the point where recording last stopped.
- When the SD PLAY Screen is in playback state, press to skip a file. (see "Playing WAV files on SD cards (SD PLAY mode)" on page 50)

31 MENU button

- When the Meter Screen is open, press to open the Home Screen.
- When the MENU Screen or a menu item settings screen is open, press to return to the Home Screen.
- When the Home Screen is open, press to open the MENU Screen. (see "Menu structure" on page 20) and (see "Basic MENU screen operations" on page 21)

32 ■ button/indicator

Press to stop playback or recording.
This button lights when stopped.
Press this button when paused to return to the beginning of the song or file.

33 ▶/|| button/indicator

Press this button to start playback.
This button lights during playback and recording.
This button blinks when paused.

34 ● button/indicator

Press this button to start recording.
This button lights during recording.
Press this button during playback to start recording (Manual punch in).

Monitoring section

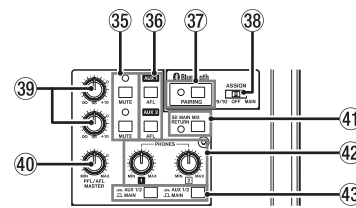

35 MUTE switch/indicator (AUX 1/AUX 2)

When MUTE switches are on (MUTE indicators lit), signals to the AUX OUTPUT AUX 1/2 jacks are muted.

36 AFL switches (AUX 1/AUX 2)

When these switches are on (pushed in), the AUX OUTPUT AUX 1/2 jack output signals are sent to the SOLO L/R bus. When these switches are on, the sound of the SOLO L/R bus can be heard through headphones.

37 PAIRING button and indicator

Press and hold this button to activate Bluetooth pairing mode.
Press when pairing to end pairing mode. (see "Connecting with Bluetooth devices" on page 24)

38 ASSIGN switch

Sound from the Bluetooth device is sent to channels 9/10 when this switch is set to "9/10" or the MAIN MIX L/R bus when it is set to "MAIN".

39 AUX 1/AUX 2 knobs

Use to adjust the output levels of the AUX OUTPUT AUX 1/2 jacks.

40 PFL/AFL MASTER knob

Use this to adjust the send level from the SOLO L/R bus.

41 SD MAIN MIX RETURN switch

When this switch is on (pushed in), playback of stereo master files recorded on the SD card is output from the MAIN OUTPUT jacks.

ATTENTION

Be aware that when this switch is on (pushed in), the sound of the MAIN MIX L/R bus is not output.

42 PHONES knob (1/2)

Use this to adjust the headphone output level.

CAUTION

Before connecting headphones, minimize the volume with the PHONES knob. Failure to do so could result in a sudden loud noise that could harm hearing, for example.

43 AUX 1/2 /MAIN switch

Turn these switches on to monitor signals from the AUX 1 and AUX 2/FX buses.

2 - Names and Functions of Parts

Analog output adjustment section

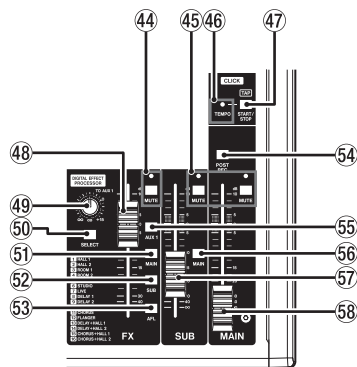

44 MUTE switch and indicator (FX)

When the MUTE switch are on (pushed in, MUTE indicator lit), the signal from the built-in effect is muted.

45 MUTE switches and indicators (SUB, MAIN)

When MUTE switches are on (MUTE indicators lit), signals to the SUB OUTPUT/MAIN OUTPUT jacks are muted.

46 TEMPO indicator

- This lights green when a song that has click sound output set is loaded.
- When the metronome is operating, it lights or blinks as follows. (see "Metronome functions" on page 41)

Indicator color	Meaning
Red	This color lights on the first beat of the setting
Green	This blinks at the set tempo

47 CLICK button

- When the EFFECT screen is open, tap this button repeatedly at the desired speed to set the delay of the built-in effect. (see "Setting the built-in effect" on page 33)
- When the TAP TEMPO screen is open, tap this button repeatedly at the desired tempo to set the metronome. (see "Making metronome settings" on page 42)
- Press this button when the metronome is stopped to start it at the set tempo. Press this button when the metronome is on to stop it. (see "Starting and stopping the metronome manually" on page 43)

48 FX fader

Use to adjust the levels of signals sent from the built-in effect to the following buses.

- MAIN MIX L/R bus
- SOLO L/R bus
- AUX1 bus
- SUB L/R bus

49 TO AUX 1 knob

Use these to adjust the levels of signals sent from the built-in effects to the AUX1 bus.

50 SELECT button

Open the EFFECT Screen and make built-in effect settings. (see "Using the built-in effects" on page 33)

The built-in effect return signal is sent to the following buses.

- MAIN MIX L/R bus
- SOLO L/R bus
- AUX1 bus
- SUB L/R bus

51 MAIN switch (FX)

When this switch is on, signals from the built-in effect are sent to the MAIN MIX L/R bus.

52 SUB switch (FX)

When this switch is on, signals from the built-in effect are sent to the SUB L/R bus.

53 AFL switch (FX)

When this switch is on, signals from the built-in effect are sent to the SOLO L/R bus.

When this switch is on, the sound of the SOLO L/R bus can be heard with headphones.

54 POST REC switch

Select the send position of the signal recorded to the SD card.

When this switch is on, signals from after the MAIN fader are recorded to the SD card.

55 AUX 1 switch (FX)

When this switch is on, signals from the built-in effect are sent to the AUX1 bus.

56 MAIN switch (SUB)

When this switch is on (pushed in), the SUB OUTPUT jack output signal is sent to the MAIN MIX L/R bus.

57 SUB fader

Use to adjust the output level of the SUB OUTPUT jacks.

58 MAIN fader

Use to adjust the output level of the MAIN OUTPUT jacks.

Rear panel

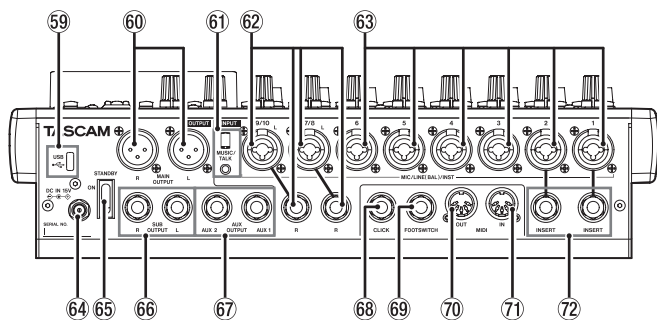

59 USB port

This is a USB Type-C port. Use a USB cable (Type-A to Type-C) to connect the unit to a computer. (see “Connecting with a Computer” on page 51)

ATTENTION

The unit should be connected directly to the computer, not through a USB hub. Moreover, noise could be picked up if the cable is too long.

60 MAIN OUTPUT L/R jacks

These analog outputs are XLR jacks.

- XLR (1: GND, 2: HOT, 3: COLD)

61 MUSIC/TALK jack (9/10, 4-pole mini jack)

This is a 4-pole mini input/output jack.

By using a cable with a 4-pole mini plug, the signals output from the MAIN OUTPUT jacks can be sent to the smartphone while simultaneously receiving input from the smartphone.

62 MIC/LINE (BAL)/INST input jacks (7/8-9/10)

These analog inputs are XLR/TRS combo jacks.

- XLR (1: GND, 2: HOT, 3: COLD)
- TRS (Tip: HOT, Ring: COLD, Sleeve: GND)

The balanced XLR jacks are for XLR balanced mic input.

The TRS jacks are for standard TRS stereo line input. If only the L jack in a pair is connected, the same signal was be sent to both left and right channels.

When directly connecting a guitar, bass or other instrument, set the INST switch to on (pushed in).

NOTE

Activating the INST switch only affects the L jack.

63 MIC/LINE (BAL)/INST input jacks (1-6)

These analog inputs are XLR/TRS combo jacks.

- XLR (1: GND, 2: HOT, 3: COLD)
- TRS (Tip: HOT, Ring: COLD, Sleeve: GND)

The balanced XLR jacks are for XLR balanced mic input.

The TRS jacks are for standard TRS mono line input.

When directly connecting a guitar, bass or other instrument, set the INST switch to on (pushed in).

64 DC IN 15V connector

Connect the included AC adapter (PS-M1524A) here. (see “Connecting the power” on page 23)

65 STANDBY switch

Press to turn the unit on and off.

CAUTION

Before turning the unit on, lower the volumes of connected equipment to their minimum levels.

Failure to do so might cause sudden loud noises, which could harm your hearing or result in other trouble.

NOTE

Do not do this when the unit is operating (including recording, playing back or writing data to an SD card). Doing so could cause proper recording to fail and recorded data to be lost.

66 SUB OUTPUT L/R jacks

These standard TRS jacks are analog outputs.

- TRS (Tip: HOT, Ring: COLD, Sleeve: GND)

67 AUX OUTPUT AUX 1/2 jacks

These standard TRS jacks are analog outputs.

- TRS (Tip: HOT, Ring: COLD, Sleeve: GND)

ATTENTION

When the AUX OUTPUT AUX 2 jack is in use, the built-in effects cannot be used. (see “Using the built-in effects” on page 33)

68 CLICK jack

This outputs the metronome click sound. (see “Setting the click sound” on page 41)

69 FOOTSWITCH jack

This standard TRS jack is for connecting a footswitch.

- TRS (Tip: FOOTSW1, Ring: FOOTSW2, Sleeve: GND)

NOTE

- This unit was designed to be used with unlatched (momentary) footswitches that have to be pushed to function (shorted when pushed). (see “Setting the footswitch polarity” on page 47)
- By using a commercially-available splitter cable, two footswitches can be used.

70 MIDI OUT connector

This 5-pin DIN is a standard MIDI output connector.

This outputs MIDI signals sent from the computer.

If the MIDI TIMECODE or MIDI CLOCK/SPP items are set to ON on the MIDI screen, those will also be output. (see “MIDI functions” on page 44)

71 MIDI IN connector

This 5-pin DIN is a standard MIDI input connector.

MIDI signals input through this connector will be sent to the computer.

72 INSERT jacks (1-2, standard)

Use these standard TRS jacks to connect external devices (effects).

- TRS (Tip: SEND, Ring: RETURN, Sleeve: GND)

2 - Names and Functions of Parts

Home Screen

When the Meter Screen is open, press the MENU button to open the Home Screen.

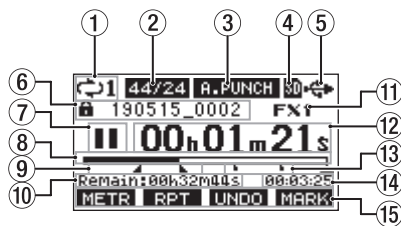

① Repeat playback status

An icon appears when the repeat playback function is on. (see "Repeat playback function" on page 35)

② Song format

This shows the current song file format.

- 44/16** 44.1kHz, 16bit
- 44/24** 44.1kHz, 24bit
- 48/16** 48kHz, 16bit
- 48/24** 48kHz, 24bit

NOTE

If no song is loaded, the operation format of the unit will be shown like **44/24** or **48/24**.

③ Automatic punch in/out function on/off status

The **A.PUNCH** icon appears when the automatic punch in/out function is on. (see "Automatic punch in/out function" on page 36)

④ SD card present status

When an SD card is loaded, the **SD** icon appears.
When an SD card is protected, the **LOCK** icon appears.
Since system files cannot be updated when the **LOCK** icon appears, automatic punch in/out settings will not be retained and previously loaded songs will not be loaded when the unit is turned on again.

⑤ USB connection status

During USB connection, the **USB** icon appears.

⑥ Song name

This shows the name of the current song.
If a song is protected, an **LOCK** icon appears before the file name. (see "Protecting/unprotecting songs" on page 29)
If a song has unsaved marks, an **+** icon appears before the file name. (see "Adding marks" on page 40)

⑦ Transport status

This icon shows the recorder operation status.

Indicator	Meaning
■	Stopped at the beginning of the file
II	Paused
●	Recording
▶	Playback

⑧ Playback position

The current playback position is shown by a bar.

⑨ Automatic punch in/out point setting status

When the automatic punch in/out function is on, these show the status of automatic punch in/out point setting.

- ▶ Punch in point
- ◀ Punch out point

⑩ Remaining time

The remaining time available for recording on the SD card is shown (in hours: minutes: seconds).

NOTE

The remaining recordable time on an SD card depends on the number of recording channels and SD card capacity.

⑪ Built-in effect status

When a built-in effect is on, the number of the effect in use is shown.

When the built-in effect is off, the **FX.MUTE** icon appears.
When the built-in effect cannot be used, the **FX.N/A** icon appears. (see "Using the built-in effects" on page 33)

⑫ Recorder time counter

This shows the elapsed time from the beginning of the song.

⑬ Mark indicators

An **■** icon is shown at each mark.

⑭ Song length

This shows the length of the current song (in hours: minutes: seconds).

⑮ Function button functions

This shows the functions assigned to the function button on the Home Screen.

- **F1** **METR** button: This opens the Meter Screen.
- **F2** **RPT** button: This turns the repeat playback function on/off.
- **F3** **UNDO** button: This returns to the state before the previous operation.
- **F3** **REDO** button: This restores the state after the previous operation.
- **F4** **MARK** button: This adds/deletes marks.
- **F4** **CLIC** button: Open the METRONOME screen where metronome functions can be set. (see "Function button setting" on page 43)

NOTE

- The **F3** button **UNDO** and **REDO** indicators appear when those operations are possible.
- Set the **F4** button function on the KEY FUNCTION screen. (see "Using mark functions" on page 40) and (see "Function button setting" on page 43)

Meters Screen

This shows the levels of the signals being input to the unit.

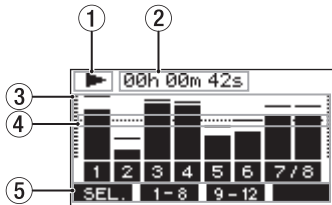

① Transport status

This icon shows the recorder operation status.

② Recorder time counter

This shows the elapsed time from the beginning of the song.

③ Track level meters

These show the signal levels of each channel.

NOTE

The **MAIN** channels show the MAIN MIX L/R bus levels.

④ Level meter guide

This provides guidance for level adjustment. The guide is shown at the -12dB level.

⑤ Function button functions

This shows the functions assigned to the function button on the Meter Screen.

- **F1 SEL.** Press to change the input sources shown on the Meter Screen.
- **F2 1-8** Press to show the level meters for channel 1-8 signals on the Meter Screen.
- **F3 9-12** Press to show the level meters for channel 9/10 and **MAIN** signals on the Meter Screen.

Meter Screen details

When the Meter Screen is open, press the **F1 SEL.** button to change the signal sources shown by the meters.

Channel input level screens

The levels of signals input on each channel are shown depending on their MODE switch settings.



LIVE INPUT Screen

This shows the levels of signals being input to the input jacks.

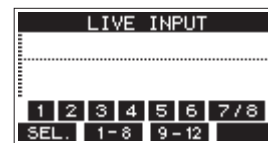

PC RETURN Screen

This shows the levels of signals output from a computer when used as a USB audio interface.

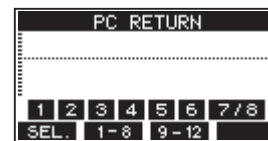

NOTE

Output from the computer, including from Windows Media Player and iTunes, is sent to channels 1-2.

MTR RETURN Screen

This shows the playback signal levels of songs recorded on SD cards.

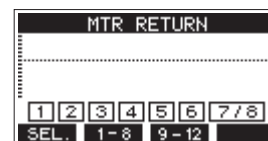

- 1 2 3 4** Channels that have recording data in the song
- 1 2 3 4** Channels that do not have recording data in the song

2 - Names and Functions of Parts

Menu structure

When the Home Screen is open, press the MENU button to open the MENU Screen.
The various menu items are as follows.

Menu item		Function	Page	
SONG		SONG Work with songs on an SD card	page 28	
CLICK	SETTING	Set click sound operation and output destination	page 41	
	METRONOME	Make specific metronome settings	page 42	
	COUNT IN	Set the count in function	page 43	
MTR	TRACK EDIT	TRACK CLEAR	Clear specific tracks or all tracks	page 38
		IMPORT	Import chosen WAV files to song tracks	page 38
		TRACK SWAP	Swap song recording files	page 39
	AUTO PUNCH		Set the auto punch in/out function	page 36
	A.PUNCH PRE ROLL		Set the pre-roll point	page 36
MIDI	MIDI TIME CODE	Set the MIDI time code	page 44	
	MIDI CLOCK/SPP	Set MIDI clock and song position pointer	page 44	
MIXER	MTR/USB SEND POINT		Set when input signals are sent	page 45
	PHASE		Set the phase of each channel	page 45
	AUX1 SEND		Set the signal sent to the AUX 1 bus	page 46
	SOLO MODE		Set the solo operation	page 46
STEREO MIX EXPORT		Use stereo mix export function	page 39	
SD PLAY		Play WAV files on an SD card	page 50	
STORAGE		SD cards can be accessed from a computer	page 51	
DAW CONTROLLER		Set the DAW controller mode	page 47	
SYSTEM	INFORMATION		View SD card information, song information and the firmware version	page 48
	DATE/TIME		Date and time settings	page 25
	SONG NAME		Set the song name format	page 48
	DISPLAY		Adjust the display	page 26
	KEY FUNCTION		Set the function of the function button	page 40 page 43
	FOOTSW		Make footswitch settings	page 47
	USB AUDIO		Make USB audio settings	page 57
	INITIALIZE		Restore factory default settings	page 49
	MEDIA FORMAT		Format the SD card	page 49

NOTE

The settings for all menu items are retained even when the unit is turned off.

2 - Names and Functions of Parts

Basic MENU screen operations

After using the MENU button to open the MENU Screen, it can be operated in the following manner.

This is an overview of basic operations. Function button assignments differ according to the screen shown on the display.

Selecting items (moving vertically on a page):

Turn the MULTI JOG dial.

Opening a submenu from a page:

Press the MULTI JOG dial.

Confirming a selected item:

Press the MULTI JOG dial (ENTER button function).

Returning to the previous screen without confirming the selected item:

Press the F1 **EXIT** button.

NOTE

Some menu items are confirmed as soon as they are selected.

Going back one step in a menu:

Press the F1 **EXIT** button.

Returning to the Home Screen from a MENU Screen:

Press the F1 **HOME** button.

Menu operation procedures

This explanation uses an example of setting the pre-roll point.

1. Press the MENU button to open the Home Screen.



2. Press the MENU button to open the MENU Screen.

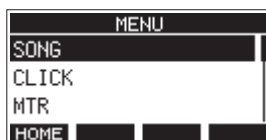

NOTE

Press the F1 **HOME** button to return to the Home Screen.

3. Turn the MULTI JOG dial to select different menu items.



4. Press the MULTI JOG dial to open a settings screen.

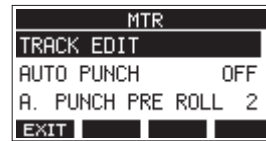

5. Turn the MULTI JOG dial to select the menu item to set.

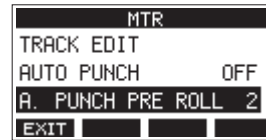

A.PUNCH PRE ROLL selected

6. Press the MULTI JOG dial to open the settings screen.

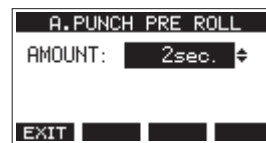

A.PUNCH PRE ROLL Screen open

7. Turn the MULTI JOG dial to change the setting.

NOTE

To cancel a setting change, press the F1 **EXIT** button.

8. To set another item on the same screen, press the MULTI JOG dial to move the cursor to the next setting.
9. Repeat steps 3 to 8 as necessary to set other items.
10. Press the F1 **EXIT** button to return to the MENU Screen.

3 - Preparation

Connecting the power supply and other equipment

This is an example of Model 12 connections.

Precautions before making connections

- Carefully read the operation manuals of the devices to be connected and then connect them correctly.
- Before making connections, turn this unit and all equipment to be connected off (standby).
- Install all connected devices, including this unit, so that they are powered from the same line. When using a power strip or similar device, be sure to use one that has high current capacity (thick cable) in order to minimize fluctuations in power voltage.
- Before connecting audio equipment, set the following knobs and faders to their lowest values. Failure to do so could cause sudden loud noises from monitoring equipment, and this could damage the equipment or harm hearing.
 - GAIN knobs (channels 1-6, 7/8-9/10)
 - Channel faders (channels 1-6, 7/8-9/10)
 - SUB fader
 - AUX 1/AUX 2 knobs
 - MAIN fader
 - PHONES knob
- Set the PHANTOM +48V switch to off.

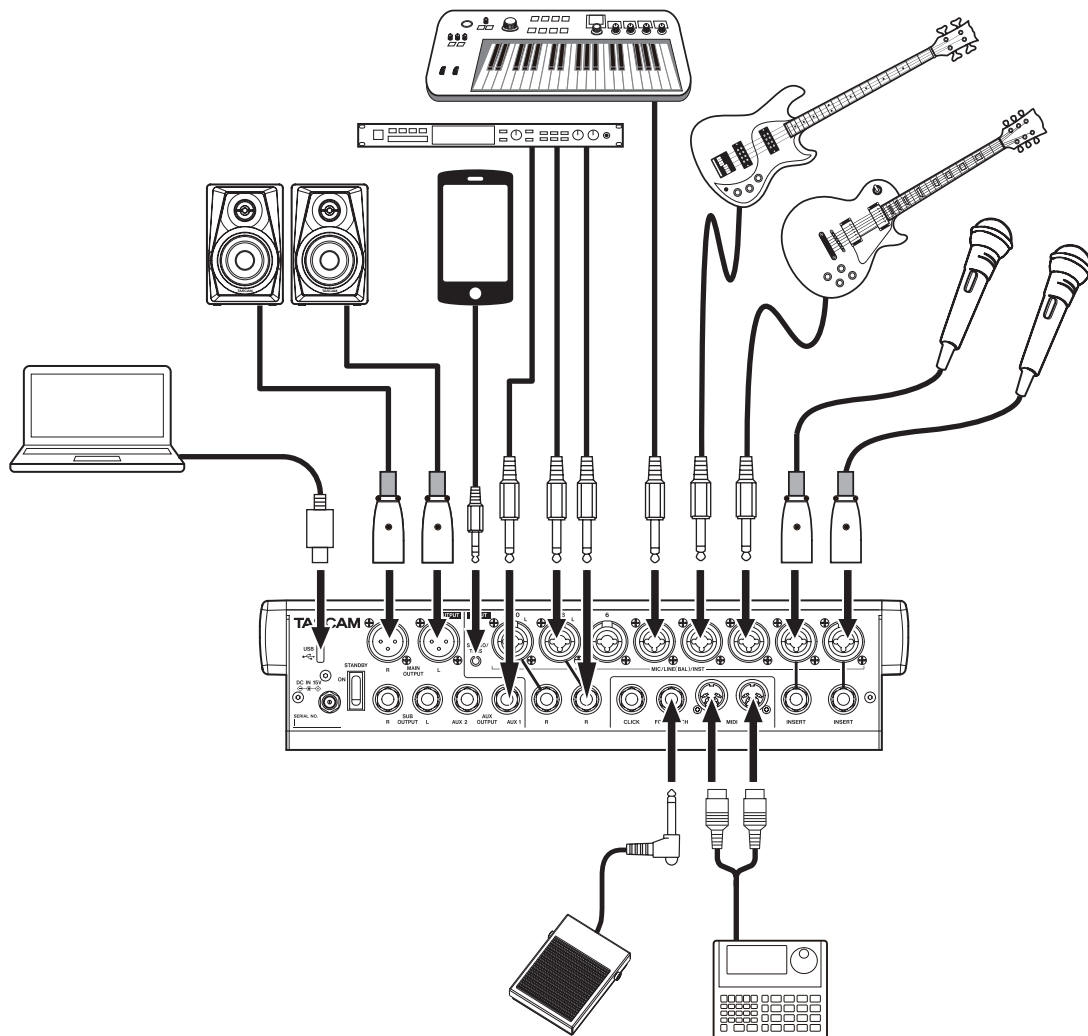

Examples of connections to a Model 12

Connecting the power

Use the included AC adapter (TASCAM PS-M1524A) to connect a power supply to the unit as shown below.

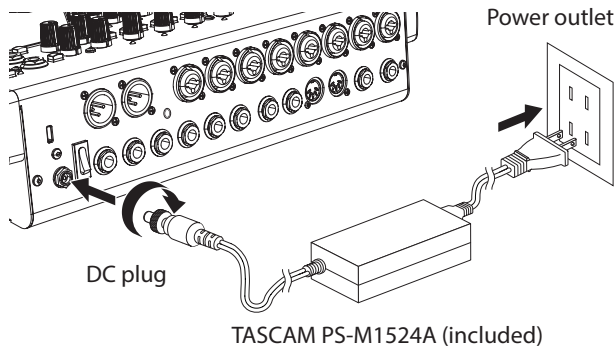

1. Connect the included AC adapter (TASCAM PS-M1524A) to the DC IN 15V connector on the back of the unit.
2. Turn the nut on the DC plug to secure it to the DC IN 15V connector.

ATTENTION

Always connect the included AC adapter (TASCAM PS-M1524A) and AC adapter power cord. Use of a different adapter could cause malfunction, fire or electric shock.

Connecting microphones

Dynamic mics

Connect them to the MIC/LINE (BAL)/INST input jacks on the back of the unit.

Condenser mics

When using a condenser microphone that requires phantom power, connect it to a MIC/LINE (BAL)/INST input jack and then turn the PHANTOM +48V switch on (pushed in). (see "Setting phantom power" on page 31)

The PHANTOM +48V indicator lights when the PHANTOM +48V switch is on (pushed in).

Connecting guitars, basses and similar instruments

When connecting a guitar, bass or other instrument with high impedance output (Hi-Z) directly to this unit, use the MIC/LINE (BAL)/INST TRS input jacks, and turn the INST switch on (pushed in) for that jack.

NOTE

When connecting an instrument with active output or when the sound passes through an effects unit, for example, that is connected to this unit, the INST switch does not need to be set to on.

Connecting electronic devices and other audio equipment

Use the following inputs to connect electronic devices and other audio equipment.

- MIC/LINE (BAL)/INST input jacks (1-6, 7/8-9/10)

NOTE

When an INST switch is on (pushed in), input through the MIC/LINE (BAL)/INST TRS input jacks will be unbalanced.

Connecting smartphones/portable audio players

Use the MUSIC/TALK jack to connect a smartphone or portable audio player.

By using a cable with a 4-pole (TRRS) mini plug to connect a smartphone, the signals output from the MAIN OUTPUT jacks can be sent to the smartphone while simultaneously receiving audio signals from the smartphone on channels 9/10.

ATTENTION

- Connecting a cable to the MUSIC/TALK jack disables signals input on channels 9/10 from the MIC/LINE jacks.
- Depending on the specifications of the connected device, normal input and output of sound signals might not be possible.

NOTE

- When signals output from the MAIN OUTPUT jacks are returned to the smartphone, echo will not occur on the smartphone because the sound from the smartphone itself is not included in those output signals.
- When using a stereo mini plug cable, only audio signal input is possible.

Connecting monitor speakers

Connect monitor speakers (powered speakers or an amplifier and speaker system) to the SUB OUTPUT jacks.

Use the SUB fader to adjust the speaker volume.

Connecting headphones

Connect headphones to the PHONES jack (standard stereo).

The following signals can be monitored according to the SOLO and AFL switch settings.

- Signals output from the MAIN OUTPUT connectors
- Signals output from the SOLO L/R bus
- Signals output from the AUX 1 bus
- Signals output from the AUX 2/FX bus

CAUTION

Before connecting headphones, minimize the volume with the PHONES knob. Failure to do so could result in a sudden loud noise that could harm hearing, for example.

Connecting a computer

Use a commercially-available Type-A-Type-C USB cable to connect the unit to a computer USB 2.0 port.

When the USB connection is working, the USB indicator in the screen operation section lights.

ATTENTION

The unit should be connected directly with the computer instead of via a USB hub. Moreover, noise could be picked up if the cable is too long.

3 - Preparation

Connecting with Bluetooth devices

This unit can input sound from a computer, portable audio device or other equipment that supports Bluetooth (A2DP).

Pairing

Follow the procedures below to enable communication with a Bluetooth device.

NOTE

Pairing also requires operation of the Bluetooth device. Refer to the operation manual of the Bluetooth device for procedures.

1. Set the ASSIGN switch to "9/10" or "MAIN".
2. Confirm that the PAIRING indicator on this unit is blinking. If it is unlit, press the PAIRING button.

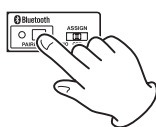

NOTE

When the unit is turned on, it automatically becomes ready for pairing. If 2 minutes pass in pairing mode, it will end. Press this button to reactivate pairing mode when it is disabled.

3. Select "Model 12" (this unit) on the other Bluetooth device. When pairing succeeds, the PAIRING indicator will stop blinking and remain lit, and connection with the other device will be complete.

NOTE

- Some older Bluetooth devices require the input of a passkey. Enter "0000" in such cases.
- Pairing will automatically end if connection is not confirmed within two minutes.
- When this unit is turned on, it will automatically try to connect with the Bluetooth device to which it was previously connected. At this time, pairing will automatically end after five minutes if connection is not possible because that Bluetooth device is not turned on or its Bluetooth function is turned off.

Unpairing

The Bluetooth device that is currently connected can be unpaired from the unit.

1. Press and hold the PAIRING button for at least two seconds.
2. This ends the pairing. The PAIRING indicator will start blinking and the unit will be ready to pair.

Inserting and removing SD cards

Inserting SD cards

Insert an SD card into the SD card slot on the top of the unit to enable playback and recording by this unit.

NOTE

SD cards can be inserted whether or not the unit is on or off.

1. Open the SD card slot cover.
2. The SD card should be inserted with its label facing left.
3. Close the SD card slot cover.

Removing SD cards

Turn the unit off or stop operation before removing an SD card.

CAUTION

Never remove an SD card when the unit is operating (including recording, playing back, or writing data to the SD card). Doing so could cause proper recording to fail, data to be lost, and sudden loud noises from monitoring equipment, which might damage the equipment, harm hearing or cause other trouble.

1. Press the SD card in gently to make it to come up.
2. Pull the SD card out.

SD card write protection switches

SD cards have write-protection switches that prevent writing new data to them.

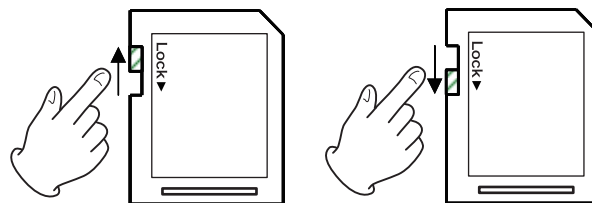

If you slide the write-protection switch to the "LOCK" position, writing will not be possible. Move the write-protection switch to the unlocked position in order to record, erase and otherwise edit data on the card.

Turning the power on and off

CAUTION

- Turn down the volume of the sound system connected to the unit before starting up or shutting down the unit.
- Do not wear connected headphones when turning the unit on and off. Loud noises could damage the speakers or harm your hearing.

Before turning the power on

1. Make the following settings on the top of the unit.
 - Other knobs → all the way left
 - Faders → all the way down
 - Switches → off (not pushed in)
2. Minimize the output levels of audio sources and input levels of amplifiers connected to this unit.

Turning the power on

1. Use the STANDBY switch on the back of the unit to turn its power on.



Startup screen

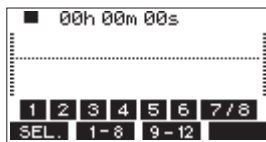

Meter Screen

After the unit starts and the Startup Screen is shown, the Meter Screen will open.

NOTE

- Press the MENU button to open the Home Screen.
 - After the unit is turned on, the PAIRING indicator will blink for a set amount of time.
2. Turn connected input audio source devices on.
 3. Finally turn amplifiers on.

Turning the power off

Before turning the power off, minimize the levels of output faders and knobs, and then follow the procedures above in reverse.

Failure to follow the correct order could result in clicking noises, for example, that might damage equipment.

CAUTION

Do not disconnect the power cord when the unit is operating (including recording, playing back, or writing data to an SD card). Doing so could cause proper recording to fail, recorded data to be lost, and sudden loud noises from monitoring equipment, which might damage the equipment, harm hearing or cause other trouble.

NOTE

When the unit is started up for the first time (or when the built-in clock is reset after being left unused without power for a long time), the DATE/TIME Screen appears before the Startup Screen to allow the date and time of the built-in clock to be set. (see "Setting the built-in clock date and time" on page 25)

Setting the built-in clock date and time

Using its internal clock, this unit includes the date and time when a file is recorded.

1. When the recorder is stopped, select DATE/TIME on the SYSTEM Screen, and open the DATE/TIME Screen. (see "Menu operation procedures" on page 21)

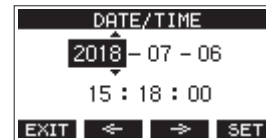

2. Turn the MULTI JOG dial to change a value, and press the MULTI JOG dial to confirm it and move the cursor to the next item.

NOTE

Use the F2 ← and F3 → buttons to move the cursor.

3. Change the year, month, day, hour and minute in order, and complete the date and time setting.
4. Press the F4 EXIT button to confirm the setting and return to the SYSTEM Screen.

NOTE

- When making a setting, you can press the F1 EXIT button to cancel the changes and return to the SYSTEM Screen.
- When setting the time, the time display will be stopped.
- By setting the TYPE item to "DATE" on the SONG NAME Screen, the date and time set here can be used for song names. (see "Setting the song name format" on page 48)

3 - Preparation

Adjusting the display

The display contrast and brightness can be adjusted.

Adjusting the display contrast

1. When the recorder is stopped, select DISPLAY on the SYSTEM Screen, and open the DISPLAY Screen. (see "Menu operation procedures" on page 21)

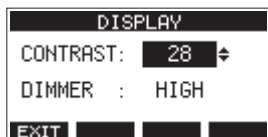

2. Adjust the display contrast.
Options: 10–40 (default: 28)
3. Press the MULTI JOG dial to confirm the setting.
4. Press the **F1 EXIT** button to return to the SYSTEM Screen.

Adjusting the display brightness

1. When the recorder is stopped, select DISPLAY on the SYSTEM Screen, and open the DISPLAY Screen. (see "Menu operation procedures" on page 21)
2. Press the MULTI JOG dial to move the cursor to the DIMMER item.

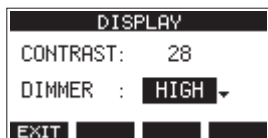

3. Adjust the display brightness.
Options: HIGH (default), LOW
4. Press the MULTI JOG dial to confirm the setting.
5. Press the **F1 EXIT** button to return to the SYSTEM Screen.

Preparing an SD card for use

In order to make an SD card usable in this unit, whether for recording or playback, this unit must be used to create a system file on it first.

ATTENTION

In order to record, this unit must be used to format it first. (see "Formatting SD cards" on page 49)

1. "No sys file. Make sys file. Are you sure?" appears in a pop up when a new card or a card formatted by another device is inserted into the unit.
2. Press the MULTI JOG dial to create a system file. When system file creation is complete, the Home Screen will reopen.

4 - Managing Songs

This recorder treats each recording data group as one song and manages data by song.

For one song, WAV files are saved for 10 tracks and a stereo master file.

To record or produce music, a song that has already been created needs to be loaded or a new song needs to be created.

This chapter describes functions that range from basic operations such as procedures for loading songs and creating new songs to various song management functions.

NOTE

The maximum recording time for a single song is 23:59:59.

Viewing the song list

To open a list of songs saved on an SD card, select SONG on the MENU Screen, and press the MULTI JOG dial to open the SONG Screen. (see "Menu operation procedures" on page 21)

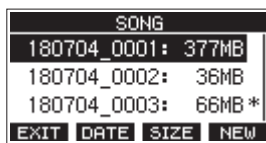

On the SONG Screen, the following functions are assigned to the function buttons.

- Press the **F1** **EXIT** button to return to the MENU Screen.
- Press the **F2** **DATE** button to show the date on the SONG Screen.
- Press the **F3** **SIZE** button to show the size on the SONG Screen.
- Press the **F4** **NEW** button to open the NEW Screen where you can create a new song. (see "Creating a New Song" on page 27)

Song Operation

Select the desired song file on the SONG Screen and press the MULTI JOG dial to open a pop-up menu list with possible song operations.

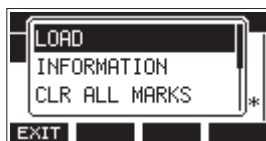

To use a song operation, turn the MULTI JOG dial to select the desired item, and press the MULTI JOG dial.

LOAD/SAVE

Loads the selected song.

When the selected song is the current song, SAVE will appear and information about it will be saved.

INFORMATION

View information about the selected song.

CLR ALL MARKS

Clear all marks in the song.

DELETE

Deletes the selected song.

PROTECT

Protect the selected song.

UNPROTECT

Stop protection of the selected song.

RENAME

Edits the name of the selected song.

Creating a New Song

To record or play with this unit, you must create and load a song. The following procedure can be used to create a new song.

1. Open the SONG Screen when the recorder is stopped. (see "Menu operation procedures" on page 21)
2. Press the **F4** **NEW** button to open the NEW Screen.

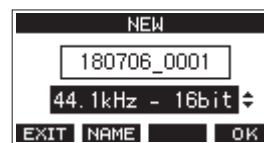

3. Turn the MULTI JOG dial to select the recording file format. Options: 44.1kHz - 16bit (default), 44.1kHz - 24bit, 48kHz - 16bit, 48kHz - 24bit
4. Edit the name of the song as necessary. To edit the name of the song, press the **F2** **NAME** button to open the NAME EDIT Screen.



For details about how to edit song names, see "Editing text" on page 29.

TIP

The song name can also be edited later using the RENAME Screen.

5. Press the **F4** **OK** button to save the currently loaded song and create a new song. When song creation completes, the SONG Screen reopens.

NOTE

- To cancel song creation, press the **F1** **EXIT** button.
- A maximum of 100 songs can be created on a single SD card.
- Songs are created in the "MTR" folder on the SD card.
- When new songs are created, the tempo is set to 120 and the time signature is set to 4/4. (see "Making metronome settings" on page 42)

4 - Managing Songs

Loading Songs

Use the following procedure to load the song you want.

1. Open the SONG Screen when the recorder is stopped. (see "Menu operation procedures" on page 21)

NOTE

The ***** icon appears for a song currently being loaded. An **🔒** icon will appear before protected songs.

2. Select the song that you want to load and press the MULTI JOG dial to open the menu list pop-up.
3. Select LOAD, and press the MULTI JOG dial.
After the selected song loads, the SONG Screen will reopen.

Saving the current song

Song information, including marks added during playback of the current song as well as deleted marks, can be saved.

1. Open the SONG Screen when the recorder is stopped. (see "Menu operation procedures" on page 21)
2. Select the current song, and press the MULTI JOG dial to open the menu list pop-up.

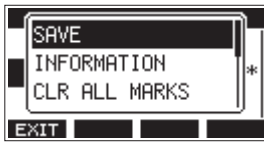

3. Select SAVE, and press the MULTI JOG dial.
This saves the song information.

ATTENTION

After saving, undoing or redoing the previous operation will no longer be possible.

Viewing song information

You can check the song name (title), sampling frequency, bit rate, size, and date and time last written.

1. Open the SONG Screen when the recorder is stopped. (see "Menu operation procedures" on page 21)
2. Select the song with information that you want to check and press the MULTI JOG dial to open the menu list pop-up.
3. Select INFORMATION, and press the MULTI JOG dial.
The INFORMATION Screen will open.

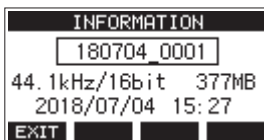

The song name, sampling frequency, bit rate, size, date and time last written will be shown.

4. After checking, press the **F1** **EXIT** button to return to the SONG Screen.

Clearing all marks

This operation clears all marks added to the selected song.

1. Open the SONG Screen when the recorder is stopped. (see "Menu operation procedures" on page 21)
2. Select the song with the marks that you want to delete and press the MULTI JOG dial to open the menu list pop-up.
3. Select CLR ALL MARKS, and press the MULTI JOG dial.
The CLR ALL MARKS Screen will open.

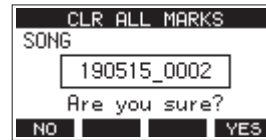

4. Press the **F4** **YES** button to confirm deletion of marks.
When mark deletion completes, the SONG Screen reopens.

ATTENTION

Deleted marks cannot be restored.

Deleting songs

You can delete songs.

Deleting unnecessary songs when the SD card space is low can create more open space.

1. Open the SONG Screen when the recorder is stopped. (see "Menu operation procedures" on page 21)
2. Select the song that you want to delete and press the MULTI JOG dial to open the menu list pop-up.
3. Select DELETE, and press the MULTI JOG dial.
The DELETE Screen will open.



4. Press the **F4** **YES** button to confirm deletion.
When song deletion completes, the SONG Screen reopens.

ATTENTION

Deleted songs cannot be restored.

NOTE

- To cancel song deletion, press the **F1** **NO** button.
- The current song cannot be deleted. To delete the current song, load another song first.

Protecting/unprotecting songs

By protecting a song, you can disable editing, recording and deletion operations for that song.

You can protect and stop protecting songs.

1. Open the SONG Screen when the recorder is stopped. (see "Menu operation procedures" on page 21)
2. Select the song that you want to protect or unprotect and press the MULTI JOG dial to open the menu list pop-up.
3. Select PROTECT or UNPROTECT, and press the MULTI JOG dial.

The PROTECT or UNPROTECT screen will open.

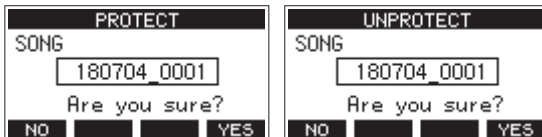

4. Press the **F4** **YES** button to protect or unprotect the song.

NOTE

To cancel protection or unprotection, press the **F1** **NO** button.

5. When song protection or unprotection completes, the SONG Screen reopens.

NOTE

- Lock icons appear before songs that are protected in the song list shown for copying, deletion and other operations.
- If you try to execute a prohibited operation (editing, recording, deletion) on a protected song, "Song is protected." will appear in a pop-up message on the display.

Editing song names

1. Open the SONG Screen when the recorder is stopped. (see "Menu operation procedures" on page 21)
2. Select the song with name that you want to change and press the MULTI JOG dial to open the menu list pop-up.
3. Select RENAME, and press the MULTI JOG dial. The RENAME Screen will open.

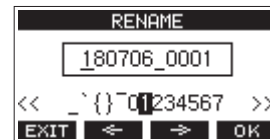

4. Edit the song name. For details about how to edit song names, see "Editing text" below.

NOTE

To cancel song name editing, press the **F1** **EXIT** button.

5. When finished editing the song name, press the **F4** **OK** button to confirm the song name. When song name editing is complete, the SONG Screen reopens.

Editing text

Use these operations to edit text.

Changing the cursor (editing point) position:

Use the **F2** **←** and **F3** **→** buttons.

You can also press the MULTI JOG dial to move to the next character.

Deleting the character at the cursor position:

Turn the MULTI JOG dial.

You can input up to 11 characters, including symbols, numbers, and uppercase and lowercase letters.

Leaving a single space open:

Turn the MULTI JOG dial to select a blank space at the left end of any row, and press the MULTI JOG dial.

Canceling edits:

Press the **F1** **EXIT** button.

Confirming the changes:

Press the **F4** **OK** button.

4 - Managing Songs

Loading songs created on different TASCAM Model series products

Songs created on TASCAM Model series products with different channel counts can be loaded on this unit.

Use the following procedure to load the song you want.

1. Open the SONG Screen when the recorder is stopped. (see "Menu operation procedures" on page 21)

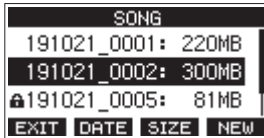

2. Select the song that you want to load and press the MULTI JOG dial to open the menu list pop-up. The name of the product used to create the song will be shown next to the LOAD item if it is different from this unit.

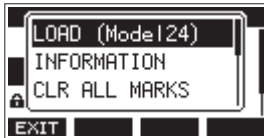

Loading a song made on a Model 24

3. Select LOAD, and press the MULTI JOG dial. After the selected song loads, the SONG Screen will reopen.

Loading a song from a unit with fewer channels on a unit with more channels

When loading a song from a unit with fewer channels on a unit with more channels, empty tracks will be created for the additional channels and the song will be converted for use with the model with more channels before loading.

Example: Loading a song from a Model 12 to a Model 24

Source song	Song after loading
Tracks 1–10	Tracks 1–10 are loaded.
-	Empty tracks are created for tracks 11–22.
Track 11 (MAIN MIX L)	This is loaded as track 23 (MAIN MIX L).
Track 12 (MAIN MIX R)	This is loaded as track 24 (MAIN MIX R).

NOTE

- If the SD card is write-protected, the song will be loaded without conversion. See "SD card write protection switches" on page 24 for details about SD card write protection.
- If a song is protected, it will be loaded without conversion. It will automatically be converted if protection is disabled. See "Protecting/unprotecting songs" on page 29 for details about song protection.

Loading a song from a unit with more channels on a unit with fewer channels

When loading a song from a unit with more channels on a unit with fewer channels, some tracks will not be available for recording and playback.

The unit will load tracks up to its number of channels from the song in order from the first.

MAIN MIX L/R tracks will be loaded as MAIN MIX L/R tracks.

The song will not be converted.

Example: Loading a song from a Model 24 to a Model 12

Source song	Song after loading
Tracks 1–10	Tracks 1–10 are loaded.
Tracks 11–22	These are not loaded.
Track 23 (MAIN MIX L)	This is loaded as track 11 (MAIN MIX L).
Track 24 (MAIN MIX R)	This is loaded as track 12 (MAIN MIX R).

5 - Basic recording

Selecting the input source

This unit has 10 input jacks (8 combo mic/line and 2 TRS line). The MIC/LINE (BAL)/INST TRS input jacks support high impedance input, including direct guitar input. Turn the INST switch on (pushed in) when connecting a guitar or similar instrument directly.

TIP

Set the INST switch to off, when connecting an electric-acoustic guitar with a built-in preamp or an active electric guitar, as well as when the signal passes through an effect device between the guitar and this unit.

Setting the MODE switch

Using the MODE switch settings of each channel to select their input sources individually.

- LIVE: Use the signal from the input jack as the input source.
- PC: Use a signal from a computer connected to the USB port as the input source.
- MTR: Use a playback signal from the SD card as an input source.

When a MODE switch is set to "MTR", the signal from the input jack on that channel will be recorded.

This function is useful when recording and playing back repeatedly because the monitored sound is automatically switched according to the recording or playback status.

Sounds on channels when in MTR mode

Transport status	REC button off	REC button on
Stop	Muted	Sound from input jack
Playing back	Playback sound only	Playback sound only + sound from input jack
Recording	Playback sound only	Sound from input jack

Setting phantom power

When connecting a condenser mic that requires phantom power, press the PHANTOM +48V switch when the recorder is stopped to turn phantom power on/off.

When phantom power is turned on, the PHANTOM +48V indicator lights and a pop-up message appears on the display to confirm turning it on.



Press the MULTI JOG dial to provide phantom power to the MIC/LINE (BAL)/INST (1-6, 7/8 and 9/10) XLR connectors.

If you set the PHANTOM +48V switch to OFF while the confirmation pop-up message is open, the message will close and phantom power will not be enabled.

CAUTION

Set the following knobs and faders to their minimum values before changing the PHANTOM +48V switch on/off setting. Depending on the connected mics, sudden loud noises from monitoring equipment could occur, and this could damage the equipment or harm hearing.

- GAIN knobs
- Channel faders
- SUB fader
- AUX1/AUX2 knobs
- MAIN fader
- PHONES knob (1/2)

ATTENTION

- Before connecting condenser mics, turn this unit and all equipment to be connected off (standby).
- The PHANTOM +48V switch turns it on/off for the input channels (1-6,7/8-9/10) simultaneously. Do not turn the PHANTOM +48V switch on (pushed in) when connecting a mic that does not require phantom power.
- Do not connect or disconnect mics when the PHANTOM +48V switch is on (pushed in). Doing so could cause a loud noise and might damage this unit and connected equipment.
- Turn the PHANTOM +48V switch on (pushed in) only when using a condenser microphone that requires phantom power. Turning the PHANTOM +48V switch on (pushed in) when a dynamic mic or other mic that does not require it is connected could damage this unit and connected equipment.
- When using condenser mics that require phantom power and dynamic mics together, be sure to use balanced dynamic mics. Unbalanced dynamic mics cannot be used when phantom power is enabled.
- Supplying phantom power to some ribbon mics could break them. If you are unsure, do not supply phantom power to a ribbon mic.

Monitoring

Monitoring is important when recording and mastering. With this unit, monitoring is possible using an external monitoring system (powered monitor speakers or an amp and speakers) or using stereo headphones.

Use the SUB fader and PHONES knob to adjust the level of the monitoring system.

5 - Basic recording

SIG indicators and level meters

The channel 1-6, 7/8-9/10 SIG indicators and level meters shown on the Meter Screen can be used to check the levels of this unit's audio signals.

The level meters are for visually checking signal levels and can also be used to check whether or not signals are being input to this unit.

For example, even if nothing can be heard when monitoring, if the Meter Screen level meters are moving, signals are being input to this unit.

The SIG indicators light green when signals (of at least -40 dB) are input through their channels.

If a SIG indicator lights red, the input source signal is too loud or the GAIN knob is turned up too far.

If the SIG indicator lights red even when the GAIN knob is turned all the way to the left, the input source signal is too loud. Lower its volume.

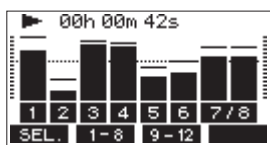

Track level meters (1-6, 7/8-9/10)

The show track playback signal or track input signal levels. Channels for which the MODE switch is set to "MTR" will show the following signal levels according to the operation status.

REC button	Transport status	Level meter display
Unlit	PLAY	Track playback signal
Blinking (recording standby)	PLAY	Playback signal Track input + playback signal
	Stop	Track input signal
Blinking (recording)	Record	Track input signal

NOTE

When the playback signal is shown, the level of the recorded signal on the track is being shown, so the levels of the level meters cannot be changed.

When the input signal is shown, adjusting channel 1-6, 7/8-9/10 GAIN knobs will change the levels of the level meters.

TIP

Please see "Meter Screen details" on page 19 for details about the Meter Screen.

MAIN MIX L/R level meters (MAIN)

These show the MAIN MIX L/R bus levels.

Recording

This unit can simultaneously record up to 12 tracks, including 10 channel inputs and the MAIN MIX L/R bus.

The following recording operations assume that mics, guitars and other things to record have been connected to the unit, input signals have been assigned as track recording sources, monitoring equipment has been connected and a song has been loaded.

1. Press the REC buttons for channel to record.
Press the REC button to start recording standby. It will blink red.
When a MODE switch is set to "MTR", the signal from the input jack on that channel will be recorded. (see "Setting the MODE switch" on page 31)

NOTE

- The MAIN MIX L/R bus does not have a REC button, but it is always in recording standby. The signals of the MAIN MIX L/R bus will always be recorded if the ● button is pressed.
- When the REC buttons of tracks that already have recordings is blinking, press them to make them unlit.

2. Set the recording levels.
Use the GAIN knobs of each channel to adjust their input levels.
Watch the SIG indicators above and to the right of the GAIN knobs, and set the levels suitably.
At the same time, check that the sound heard through headphones or a monitoring system is not distorted and that an unintended effect has not been set.

NOTE

If an input is too loud, the SIG indicator will light red. If the SIG indicator lights red even when its GAIN knob is turned all the way to the left, lower the volume of the input source.

3. Press the ● button.
Recording will start and the ● and ►/|| buttons will light.
The REC buttons for tracks to record will stop blinking and stay lit.
4. When recording has completed, press the ■ button.
5. Use the ◀◀/▶▶ buttons and ■ button, for example to locate to a position you want to check.

TIP

For details about the locate function, see "Locate function" on page 35.

6. Press the ►/|| button to play the recorded tracks.
Use the channel and MAIN faders to adjust the playback levels.
Use the volume of the monitoring system to adjust the final monitoring level.
Use the PAN knobs of each channel to set the position of each track signal between left and right speakers.

NOTE

- The channel PAN knobs and channel faders control the playback output signals of already recorded tracks or the monitoring volume of input signals. They do not control signals to be recorded.
- If you are not satisfied with a recording, repeat the above procedure from the beginning.

Undoing operations

If you make a mistake operating the unit or want to do a recording over, for example, the operation last conducted can be undone. Editing, recording and other operations can be undone. The following types of operations can be undone.

- Recording operations
- Auto punch in/out operations
- Track clearing operations

If a song is loaded or the unit is turned off, Information used for undoing and redoing will be lost, so undoing and redoing previous operations will no longer be possible.

NOTE

Files used for undoing are temporarily saved on the SD card. If you want to delete those files to make more space on the SD card, reload the current song on the SONG Screen.

Undoing the previous operation

1. When the Home Screen is open, press the **F3 UNDO** button.



The following confirmation pop-up message will appear.

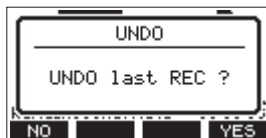

2. Press the **F4 YES** button to return to the state before the previous operation.

NOTE

To cancel undoing, press the **F1 NO** button.

Redoing an undone operation

1. After undoing, when the "REDO" appears on the Home Screen, press the **F3 REDO** button. The following confirmation pop-up message will appear.

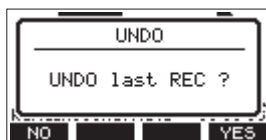

2. Press the **F4 YES** button to restore the previous operation and return to the state before undoing.

NOTE

To cancel redoing, press the **F1 NO** button.

Using the built-in effects

This unit has built in effects, so you can apply effects without an external effect device.

Channels 1-6 and 7/8-9/10 can have an effect applied. Their signals are sent to the built-in effect by the AUX2/FX bus.

The return signal is sent to the following buses.

- MAIN MIX L/R bus
- SOLO L/R bus
- AUX1 bus
- SUB L/R bus

ATTENTION

When the AUX OUTPUT AUX 2 jack is in use, **FX, N/A** appears on the Home Screen and the built-in effects cannot be used.

1. Use the AUX 2/FX knobs of each channel to adjust the levels of signals sent to the AUX2/FX bus.
2. Use the EFFECT Screen to select the type of effect. (see "Setting the built-in effect" on page 33)
3. Use the FX fader and TO AUX 1 knob to adjust the return levels for each bus.

Setting the built-in effect

1. Press the SELECT button to open the EFFECT Screen.

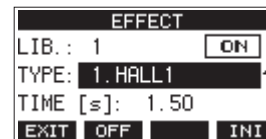

2. Turn the MULTI JOG dial, and set the built in effect type.
 - Options: 1.HALL1 (default), 2.HALL2, 3.ROOM1, 4.ROOM2, 5.PLATE, 6.STUDIO, 7.LIVE, 8.DELAY1, 9.DELAY2, 10.PING PONG, 11.CHORUS, 12.FLANGER, 13.DELAY+HALL1, 14.DELAY+HALL2, 15.CHORUS+HALL1, 16.CHORUS+HALL2
3. Press the MULTI JOG dial to select the PARAMETER item. The parameter item is dependent on the selected effect.

5 - Basic recording

- Turn the MULTI JOG, and adjust the set effect.
You can check the effect as you change it.

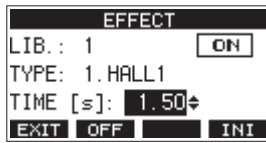

NOTE

- Turn the MULTI JOG dial to change the **F4** button function from **INI** to **UNDO**. Press the **F4 UNDO** button to return to the state before turning the MULTI JOG dial.
- Press the **F4 INI** button to set a parameter value to its default.
- "**TAP**" appears for effects that include delay. When the TIME parameter item is selected, the CLICK button can be pressed repeatedly at the desired speed to set the tempo.

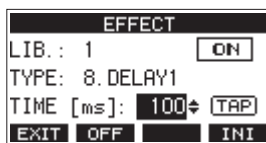

- When the footswitch setting is "TAP", the footswitch can be used instead of the CLICK button for TAP delay input. (see "Setting up the footswitch" on page 47)
- Press the **F2 OFF** button to turn the built-in effect on/off. The **A** item on the EFFECT screen shows the built-in effect status.

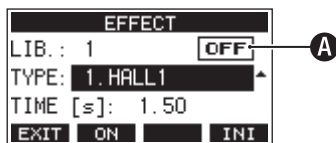

Status	Meaning
ON (default)	The built-in effect is on.
OFF	The built-in effect is off.
N/A	The built-in effect cannot be used (because the AUX 2 jack is in use).

NOTE

When the built-in effect is off, the icon appears on the **FX.MUTE** Home Screen.

- Press the **F1 EXIT** button to return to the Home Screen.

Using the library

This unit has a library function that allows up to 10 built-in effect settings to be saved.

Saving effects settings in the library

- Press the SELECT button to open the EFFECT Screen.
- Press the MULTI JOG dial to select the LIB item.

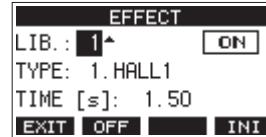

- Turn the MULTI JOG dial to select the library number to save.
- Follow the procedures in "Setting the built-in effect" to set the built-in effect.
This saves the effect setting in the library.

Using an effect setting saved in the library

- Press the SELECT button to open the EFFECT Screen.
- Press the MULTI JOG dial to select the LIB item.
- Turn the MULTI JOG dial to select the library number with the saved effect setting you want to use.
This applies the saved effect setting.

6 - Recorder functions

Locate function

When the Home Screen is open, you can use the MULTI JOG dial to set the locate point.

On the Home Screen, the current position of the recorder is shown as a time in hours (h), minutes (m) and seconds (s).

By setting the time in this display area, you can change the current position of the recorder.

Changing the playback position

When the Home Screen is open and the recorder is stopped or playing back, you can use the MULTI JOG dial to set the locate point.

Using the direct locate function to locate

1. When the Home Screen is open and the recorder is stopped, press the MULTI JOG dial to enable direct locate mode. A cursor will appear at the location to be changed in the recorder counter.

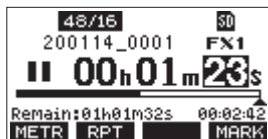

2. Turn the MULTI JOG dial to change a value, and press the MULTI JOG dial to confirm it and move the cursor to the next item.
3. Change the seconds, minutes and hours in that order to move to that time as the current recorder position.
4. Press the ►/|| button to start playback or the ● button to start recording from that position.

Repeat playback function

The repeat playback function can be used to play something over and over.

When the Home Screen is open, press the **F2** **RPT** button to set the repeat playback function.

Nothing shown: The current song will keep playing regardless of whether the area is recorded or not.

S1: The current song will play and then stop.

↻1: The current song will play repeatedly.

Punch in/out function

Punching in and out is a technique used to replace parts of already recorded tracks.

You can start playback of a recording, switch to recording when it reaches the part to be replaced (punch in), and then switch back to playback when the end of that part is reached (punch out) and stop after two seconds.

1. Determine the part you want to replace in advance. Select a point where the replacement audio can be combined well with the original track audio.

2. Press the REC button for the track with the part to be replaced to enter recording standby (REC button blinks).

NOTE

- Set the punch in and out points at least one second apart.
 - Punch in recording is not possible when the REC button is on for eight or more channels.
3. Start playback before the part to be replaced.
 4. When the part to be replaced is reached, press the ● button, and perform the part. Recording will start (punch in).
 5. When the end of the part to be replaced is reached, press the ■ button. The unit will switch to playback and then stop after two seconds.

Using the footswitch to punch in/out

By connecting the recommended TASCAM RC-1F footswitch (sold separately) to the FOOTSWITCH jack on the top of the unit, you can use it to punch in/out.

To use a footswitch to punch in/out, you must set the foot switch function assignment to "PUNCH I/O" in advance. (see "Setting up the footswitch" on page 47)

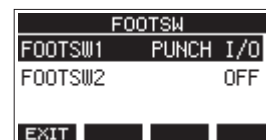

At step 4 above, press the footswitch instead of the ● button, and at step 5 press it again instead of the ■ button.

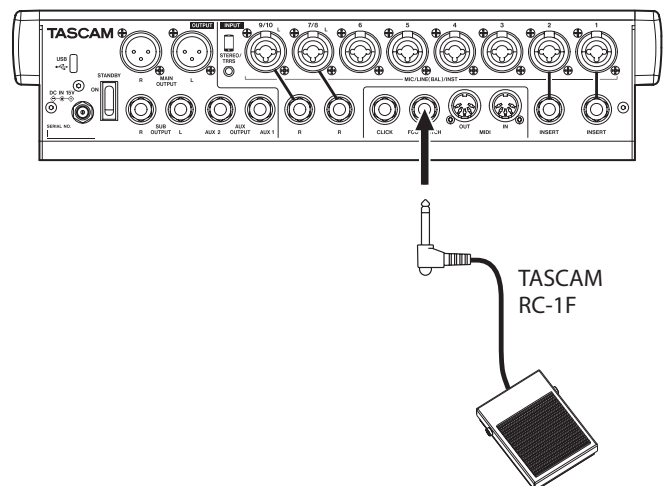

NOTE

This unit was designed to be used with unlatched (momentary) footswitches that have to be pushed to function (shorted when pushed).

6 - Recorder functions

Automatic punch in/out function

Using the automatic punch in/out function, you can automatically record between punch in and out points set in advance.

To use the automatic punch in/out functions, start playback from a pre-roll point before the punch in point where recording will start.

Recording will stop when the punch out point is reached, but playback will continue for two seconds before stopping.

Setting the punch in/out points

1. When the recorder is stopped, select MTR on the MENU Screen, and open the MTR Screen. (see "Menu operation procedures" on page 21)
2. Select AUTO PUNCH on the MTR Screen, and open the AUTO PUNCH Screen.

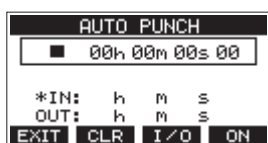

3. Press the ►/|| button to start playback.
4. Press the MULTI JOG dial to set the punch in and out points. The set points are shown next to the IN and OUT items.

NOTE

- You can also turn the MULTI JOG dial to set the points.
 - Set the punch in and out points at least one second apart.
 - Press the F2 CLR button to clear set punch in and out points.
 - Press the F3 I/O button to select either the punch in or out point. An ✚ icon will appear next to the selected item.
5. Press the ■ button to stop playback.
 6. Press the F4 ON button to turn the automatic punch in/out function on. The A.PUNCH icon appears on the AUTO PUNCH Screen.

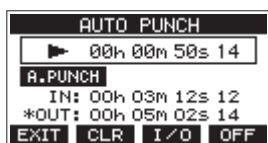

7. Press the F1 EXIT button to return to the MENU Screen.

TIP

- By setting only the punch in point, you can start recording with automatic punch in and then continue recording until you press the ■ button to stop.
- By setting only the punch out point, you can start recording by pressing the ● button and then stop recording with automatic punch out.

Setting a pre roll point

When using automatic punch in, the amount of playback time before the punch in point can be set (pre roll point).

1. When the recorder is stopped, select MTR on the MENU Screen, and open the MTR Screen. (see "Menu operation procedures" on page 21)
2. Select A.PUNCH PRE ROLL on the MTR screen to open the A.PUNCH PRE ROLL screen.

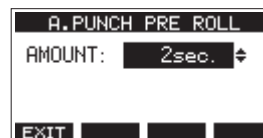

3. Set the pre-roll point.

Option	Meaning
OFF	Do not locate to a point before the punch in point. Manually moving to somewhere before the punch in point beforehand will be necessary.
1sec. – 10sec. (default: 2sec.)	Locate to a pre roll point the set time before the punch in point and start playback.

4. Press the F1 EXIT button to return to the MTR Screen.

Rehearsing punching in and out

You can rehearse before punch in/out recording. In rehearsal, recording will not occur, but monitoring will be the same as if recording.

1. Press the MENU button when the recorder is stopped to open the Home Screen. Confirm that the A.PUNCH icon appears on the Home Screen.

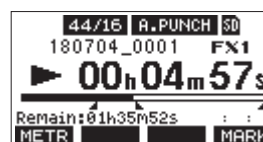

2. Press the REC buttons for the tracks you want to record using automatic punch in/out.

NOTE

Punch in recording is not possible when the REC button is on for eight or more channels.

3. Press the ►/|| button. Auto punch in/out rehearsal starts.
 - The transport starts playback from the pre-roll point. Both track playback and input source signals can be monitored. (see "Setting a pre roll point" on page 36)
 - When the punch in point is reached, only the input source signal will be monitored. The ● button will blink showing that it is rehearsal mode.
 - When the punch out point is reached, both track playback and input source signals will be monitored. The ● button will become unlit.
 - Playback will automatically stop two seconds after the punch out point. The ►/|| button will blink.

Rehearsal can be repeated.

Using automatic punching in and out

Follow these procedures to punch in and out automatically and record.

1. Confirm that the **A.PUNCH** icon appears on the Home Screen.
2. Press the REC buttons for the tracks you want to record using automatic punch in/out.

NOTE

Punch in recording is not possible when the REC button is on for eight or more channels.

3. Press the ● button.
 - The transport starts playback from the pre-roll point. Both track playback and input source signals can be monitored. (see "Setting a pre roll point" on page 36)
 - When the punch in point is reached, only the input source signal will be monitored. The ● button will light.
 - When the punch out point is reached, both track playback and input source signals will be monitored. The ● button will become unlit.
 - Playback will automatically stop two seconds after the punch out point. The ►/|| button will blink.

7 - Track editing

Clearing tracks

The selected track will be cleared.

1. When the recorder is stopped, select MTR on the MENU Screen, and open the MTR Screen. (see “Menu operation procedures” on page 21)



2. Select TRACK EDIT on the MTR Screen, and open the TRACK EDIT Screen.



3. Select TRACK CLEAR on the TRACK EDIT Screen, and open the TRACK CLEAR Screen.

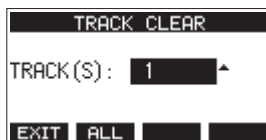

4. Turn the MULTI JOG dial to select the track to clear, and press the MULTI JOG dial. A confirmation message will appear.

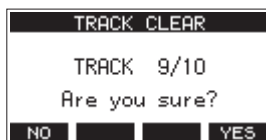

NOTE

Press the **F2** **ALL** button to open a message asking to confirm that you want to clear all tracks.



5. Press the **F4** **YES** button to clear the track(s).

NOTE

- To cancel clearing tracks, press the **F1** **NO** button.
 - Undoing is possible only for the last cleared track.
6. After clearing tracks completes, the TRACK CLEAR Screen will reopen.

Importing tracks

You can import audio files that you have to tracks in the current song.

Files that can be imported to tracks must be WAV (BWF) format (“WAV” extension).

To import an audio file with a different format (.mp3, etc.) to this unit, it must be converted to a WAV file that matches the format of the song it will be imported into beforehand.

1. Connect this unit with a computer. (see “Connecting with a Computer” on page 51)
2. Use the computer to copy WAV files on it to this unit’s “MUSIC” folder.
3. Follow the proper disconnection procedures on the computer before disconnecting the USB cable. (see “Disconnecting” on page 52)
4. When the recorder is stopped, select MTR on the MENU Screen, and open the MTR Screen. (see “Menu operation procedures” on page 21)
5. Select TRACK EDIT on the MTR Screen, and open the TRACK EDIT Screen.
6. Select IMPORT on the TRACK EDIT Screen, and open the TRACK IMPORT Screen. WAV files in the “MUSIC” folder will be shown.

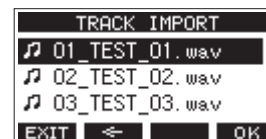

7. Select a WAV file to import.
 - Turn the MULTI JOG dial to select a WAV file.
 - Press the MULTI JOG dial when a folder is selected to show its contents.
 - Press the **F1** **EXIT** button to return to the MENU Screen.
 - Press the **F2** **←** button to move up one level.
8. Press the **F4** **OK** button. A confirmation message will appear if the bit length of the WAV file to be imported differs from the current song.



Confirmation message example

- Press the **F1** **NO** button to return to the TRACK IMPORT screen.
- Press the **F4** **YES** button to continue to the TRACK IMPORT screen. In this case, the file will be imported and the bit length will be changed to match the current song.

NOTE

- If there are no openings for tracks to import, an “Import error. No track” pop-up message will appear.
- To cancel importing a track, press the **F1** **NO** button.
- Importing is not possible under the following conditions.
 - Not enough open space is available on the SD card
 - There are no empty tracks

- If the sampling frequency of the WAV file you are trying to import differs from the current song
Example: Trying to import a 48kHz WAV file when the current song is 44.1kHz
 - If there is no file that can be imported, a “No File” pop-up message will appear.
9. Select the track to import, and press the **F4** **YES** button to import it.

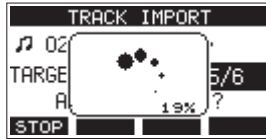

When importing completes, the TRACK IMPORT Screen reopens.

NOTE

- Press the **F1** **STOP** button to cancel importing.
- The part of the track imported before canceling will remain; it will not be deleted.

Swapping tracks

Recorded tracks can be swapped with other tracks.

1. When the recorder is stopped, select MTR on the MENU Screen, and open the MTR Screen. (see “Menu operation procedures” on page 21)
2. Select TRACK EDIT on the MTR Screen, and open the TRACK EDIT Screen.
3. Select TRACK SWAP on the TRACK EDIT Screen, and open the TRACK SWAP Screen.



4. Turn the MULTI JOG dial to select a track.
Options: 1 (default), 2, 3, 4, 5, 6, 7, 8, 7/8, 9, 10, 9/10, 11, 12, 11/12
5. Press the MULTI JOG dial to move the cursor to the B item.
6. Turn the MULTI JOG dial to select a track.
Options: 1 (default), 2, 3, 4, 5, 6, 7, 8, 7/8, 9, 10, 9/10, 11, 12, 11/12
7. Press the **F4** **YES** button to swap the track specified in the A and B items.

NOTE

This can be used as a basic bounce function by swapping the signals recorded on tracks 11/12 (the output from the MAIN OUTPUT connectors) to other tracks, and then clearing all the other tracks.

Stereo mix export function

MAIN MIX L/R bus recording files (mono) can be converted to a single stereo file.

Converted stereo files are saved in the “MUSIC” folder.

Saved files are named according to the song name. For example, the file name will be “181228_0002_2-MIX_01.wav” if the song name is “181228_0002”.

If the size of the converted file would exceed 2 GB, multiple files will be created with numbers like “02” and “03” at their ends.

1. Load the song to be exported as a stereo mix in advance.
For details about loading songs, see “Loading Songs” on page 28.
2. When the recorder is stopped, select STEREO MIX EXPORT on the MENU Screen, and open the STEREO MIX EXPORT Screen. (see “Menu operation procedures” on page 21)



3. Press the **F4** **YES** button to start conversion.



NOTE

- If a converted file already exists, a message to confirm overriding appears.

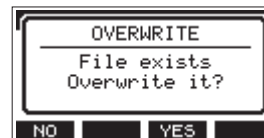

Press the **F3** **YES** button to delete the existing file and start conversion. This operation cannot be undone.

- Conversion is not possible if no MAIN MIX L/R bus file has been recorded. The message shown below will appear.



- During conversion, press the **F1** **STOP** button to cancel conversion. A file with the part converted before canceling will remain.
4. When conversion completes, the MENU Screen will reopen.

NOTE

Converted files can be played using this unit’s SD PLAY mode. For details about playback with the SD PLAY mode, see “Playing WAV files on SD cards (SD PLAY mode)” on page 50.

8 - Mark functions

Marks can be used to cue for playback, for example. In addition to use with this unit, mark information added to WAV files can be used with software, for example, that supports the BWF format.

Using mark functions

In order to set and clear marks, the Home Screen **F4** button function must be switched to **MARK**.

NOTE

When the unit is purchased new, **MARK** appears on the Home Screen. There is no need to change the function of the **F4** button before use.

1. When the recorder is stopped, select **KEY FUNCTION** on the **SYSTEM** Screen, and open the **KEY FUNCTION** Screen. (see "Menu operation procedures" on page 21)

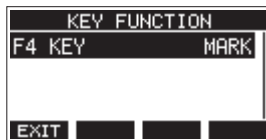

2. Press the **MULTI JOG** dial to open the **F4 KEY** Screen.
3. Turn the **MULTI JOG** dial to select **MARK**.



4. Press the **MULTI JOG** dial to confirm the setting. The **KEY FUNCTION** Screen reopens.

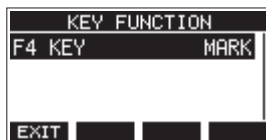

Adding marks

When playing or recording, press the **F4 MARK** button to add a mark at the current point.

When a mark is added, a pull-up showing the mark number appears at the bottom of the display.

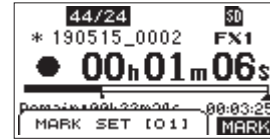

Mark icons appear below the playback position bar where marks are set.

- The [xx] in the mark name is a number given to all marks that is incremented in order.
- Marks added during recording will automatically be saved in the song when recording stops.
- Marks added during playback will not be automatically saved. Save song information after stopping playback to save mark data. (see "Saving the current song" on page 28)

NOTE

If an icon appears at the beginning of a song name, it has unsaved mark data. Save the song information to save the mark data. (see "Saving the current song" on page 28)

Moving between marks

When stopped, paused or playing back, press the **◀◀** or **▶▶** button to move (skip) to the previous or next mark.

When skipping, the mark name appears in a pull-up at the bottom of the display.

Clearing individual marks

Marks can be cleared when stopped or paused.

1. Skip to a mark that you want to delete when stopped or paused. (see "Moving between marks" on page 40)
2. Press the **F4 MARK** button to open the **Mark Clear** confirmation screen.



3. Press the **F4 YES** button to clear the mark.

NOTE

- Repeat steps 1 - 3 to clear multiple marks.
- To clear all marks in the current song, select the **CLR ALL MARKS** item from the menu list shown on the **SONG** Screen. (see "Clearing all marks" on page 28)

Metronome functions

This unit has a built-in metronome.

Click sound and metronome settings can be made for each output separately.

NOTE

Metronome function settings are saved in the current song. The settings saved in the song can be used the next time it is loaded.

Setting the click sound

The output can be set for the metronome click sound. The setting procedures differ according to the output destination.

Setting the click sound output from the CLICK jack

1. When the recorder is stopped, select SETTING on the CLICK Screen, and open the CLICK SETTING Screen. (see "Menu operation procedures" on page 21)

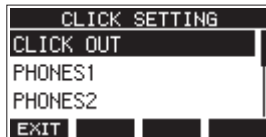

2. On the CLICK SETTING Screen, select CLICK OUT, and open the CLICK OUT Screen.

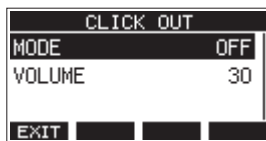

3. Select MODE on the CLICK OUT Screen, and open the MODE Screen.

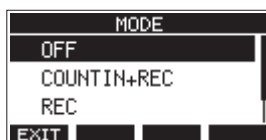

4. Turn the MULTI JOG dial to select the click sound output mode.

Option	Meaning
OFF (default)	Click is not output with recording or playback
COUNT IN+REC	Click is output during count in and recording
REC	Click is output during recording
REC&PLAY	Click is output during recording and playback

5. Press the MULTI JOG dial to confirm the setting. The CLICK OUT Screen reopens.

6. Select VOLUME on the CLICK OUT Screen, and open the VOLUME Screen.

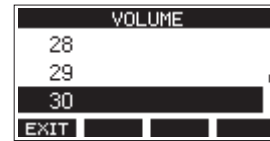

7. Turn the MULTI JOG dial to set the CLICK jack output level. Options: 0–50 (default: 30)
8. Press the MULTI JOG dial to confirm the setting. The CLICK OUT Screen reopens. Starting recording or playback will cause the click to be output according to the setting. When the setting is enabled, the TEMPO indicator flashes in time with the metronome tempo. The metronome signal is not recorded even if set to work during recording.

NOTE

- When the metronome is working, you can monitor the sound of the metronome through connected external speakers. Note, however, in this case that the metronome sound could also be recorded if you are using a microphone to record in the same room.
- When the metronome is running, the output level settings on various output VOLUME screens can be adjusted, but other items cannot be changed.
- You can use the metronome as a click track to help keep time when recording rhythm guitar or bass, for example, as the first tracks of a song.
- If you want to use the metronome alone for practice, you can either turn each track's fader all the way down during playback or play a song that does not have any recordings.

9 - Other functions

Setting the click sound output from the PHONES jacks and buses (MAIN MIX L/R, AUX 1, AUX 2/FX, SUB L/R)

1. When the recorder is stopped, select SETTING on the CLICK Screen, and open the CLICK SETTING Screen. (see "Menu operation procedures" on page 21)
2. Select the following items on the CLICK SETTING Screen, and open the corresponding settings screens.

Option	Meaning
PHONES1	Settings for click sent to the PHONES 1 jack
PHONES2	Settings for click sent to the PHONES 2 jack
SUB BUS	Settings for click sent to the SUB L/R bus
MAIN BUS	Settings for click sent to the MAIN MIX L/R bus
AUX1	Settings for click sent to the AUX 1 bus
AUX2	Settings for click sent to the AUX 2/FX bus

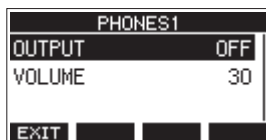

Settings screen when PHONES1 selected

3. Select OUTPUT on the settings screen, and open the OUTPUT Screen.

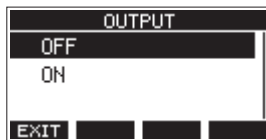

4. Turn the MULTI JOG dial to select the click sound sent to the CLICK jack.

Option	Meaning
OFF (default)	No click is sent.
ON	Click is sent.

5. Press the MULTI JOG dial to confirm the setting. The settings screen reopens.
6. Select VOLUME on the screen shown, and open the VOLUME Screen.



7. Turn the MULTI JOG dial to set the CLICK jack output level. Options: 0–50 (default: 30)
8. Press the MULTI JOG dial to confirm the setting. The settings screen reopens.

Making metronome settings

Specific metronome settings can be made.

1. When the recorder is stopped, select CLICK on the MENU Screen, and open the CLICK Screen. (see "Menu operation procedures" on page 21)
2. Select METRONOME on the CLICK Screen, and open the METRONOME Screen.

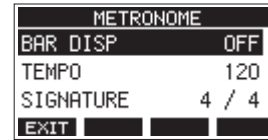

3. Turn the MULTI JOG dial to select a metronome setting item. Then, press the MULTI JOG dial. The corresponding setting item screen will open.

BAR DISP

This sets the display of the time counter on the Home Screen.

Options: OFF (default), ON



When ON, the time counter on the Home Screen switches to bars and beats, showing the tempo and time signature in the **B** area.

The maximum number of bars that can be shown is 10000.

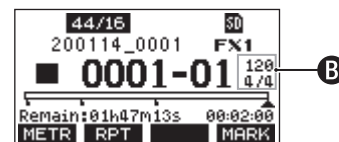

TEMPO

This sets the tempo.

The setting range is from 20 to 250 (BPM). (Default: 120)

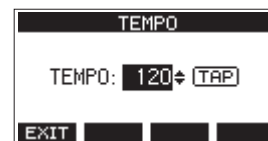

Turn the MULTI JOG dial to set the tempo.

The CLICK button can also be tapped repeatedly at the desired tempo to set it.

When the footswitch function is "TAP", the footswitch can also be used for input. (see "Setting up the footswitch" on page 47)

SIGNATURE

Set the time signature to 4/4, 3/4, etc.
The setting range is from 1/1 to 12/8. (Default: 4/4)



SOUND

This sets the click sound.

Options: CLICK (default), STICK, BELL, KICK, SNARE, PEDAL HIHAT, OPEN HIHAT, CLOSE HIHAT

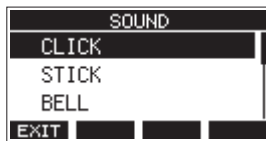

Setting the count in function

When the click sound output setting is set to COUNTIN+REC, counting in before recording is possible. The click sound pattern played before recording starts can be set.

1. When the recorder is stopped, select CLICK on the MENU Screen, and open the CLICK Screen. (see "Menu operation procedures" on page 21)
2. Select COUNT IN on the CLICK Screen, and open the COUNT IN Screen.

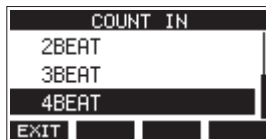

3. Turn the MULTI JOG dial to set the count in type.

Option	Meaning
SIGNATURE	One bar of beats for the set SIGNATURE are output. The first beat of the bar is accented.
2SIGNATURES	Two bars of beats for the set SIGNATURE are output. The first beat of the bar is accented.
2+4BEAT	Regardless of the signature setting, one bar of half notes followed by one bar of quarter notes are output. No beat is accented.
2BEAT	Regardless of the signature setting, two quarter notes are output. No beat is accented.
3BEAT	Regardless of the signature setting, three quarter notes are output. No beat is accented.
4BEAT (default)	Regardless of the signature setting, four quarter notes are output. No beat is accented.

4. Press the MULTI JOG dial to confirm the setting. The CLICK Screen reopens.

Starting and stopping the metronome manually

The metronome can be started and stopped at any time by pressing the CLICK button.

- Press the CLICK button when the metronome is off to start it.
- Press the CLICK button when the metronome is on to stop it.

Function button setting

By changing the **F4** button function on the Home Screen from **MARK** to **CLIC**, the METRONOME screen where metronome functions can be set can be opened directly from the Home Screen.

1. When the recorder is stopped, select KEY FUNCTION on the SYSTEM Screen, and open the KEY FUNCTION Screen. (see "Menu operation procedures" on page 21)

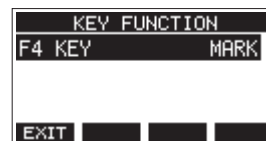

2. Press the MULTI JOG dial to open the F4 KEY Screen.



3. Turn the MULTI JOG dial to select CLICK.
4. Press the MULTI JOG dial to confirm the setting. The KEY FUNCTION Screen reopens.
5. Open the Home Screen to show that **CLIC** is assigned to the **F4** button.



NOTE

Press the **F4 CLIC** button to open the METRONOME Screen.

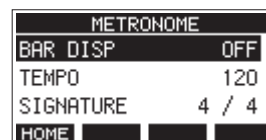

9 - Other functions

MIDI functions

This unit can generate MIDI TIME CODE and MIDI CLOCK when the recorder is playing back or recording.

The generated MIDI data is output from the MIDI OUT connector and simultaneously sent to a computer connected by USB.

A DAW, for example, can be set to synchronize with the MIDI time code from this unit so it can operate in time with the recorder of this unit.

For details, check the operation manual of the hardware or software product being used.

MIDI settings are made on the following screen.



Setting MIDI time code operation

When MIDI time code is enabled, it sends quarter-frame messages during playback and recording. It sends full messages when locating.

1. When the recorder is stopped, select MIDI TIMECODE on the MIDI Screen, and open the MIDI TIMECODE Screen. (see "Menu operation procedures" on page 21)

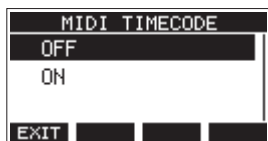

2. Turn the MULTI JOG dial to set MIDI time code operation.

Option	Meaning
OFF (default)	MIDI time code is not transmitted.
ON	MIDI time code is transmitted.

NOTE

The MIDI time code frame type sent by this unit is 30 frames per second (non-drop).

3. Press the MULTI JOG dial to confirm the setting. The MIDI Screen reopens.

Setting MIDI CLOCK/SPP

When MIDI CLOCK/SPP is enabled, MIDI CLOCK is sent during playback and recording.

Song position pointers are sent when locating.

The MIDI Clock timing and song positions sent depend on the metronome settings.

1. When the recorder is stopped, select MIDI CLOCK/SPP on the MIDI Screen, and open the MIDI CLOCK/SPP Screen. (see "Menu operation procedures" on page 21)

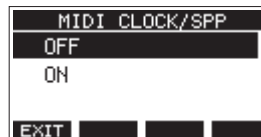

2. Turn the MULTI JOG dial to set whether or not MIDI CLOCK/SPP is sent.

Option	Meaning
OFF (default)	MIDI CLOCK/ SPP is not sent.
ON	MIDI CLOCK/ SPP is sent.

3. Press the MULTI JOG dial to confirm the setting. The MIDI Screen reopens.

Mixer functions

Selecting the positions that recording signals are sent from each channel

The signals that are sent from each channel for recording to an SD card can be set to before or after the compressor or after the equalizer.

1. When the recorder is stopped, select MIXER on the MENU Screen, and open the MIXER Screen. (see "Menu operation procedures" on page 21)



2. Select MTR/USB SEND POINT on the MIXER Screen, and open the MTR/USB SEND POINT Screen.

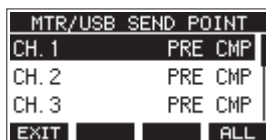

NOTE

Press the **F4 ALL** button to change the settings for all channels at the same time.

3. Select the channel to be changed, and press the MULTI JOG dial. This opens the setting screen for the selected channel.

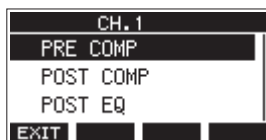

4. Turn the MULTI JOG dial to select the send position.

Option	Meaning
PRE COMP (default)	The signal of the channel is recorded to the SD card before the compressor.
POST COMP	The signal of the channel is recorded to the SD card after the compressor.
POST EQ	The signal of the channel is recorded to the SD card after the equalizer.

5. Press the MULTI JOG dial to confirm the setting. The MTR/USB SEND POINT Screen reopens.

Setting the phase of each channel

The phase of each channel can be set.

1. When the recorder is stopped, select MIXER on the MENU Screen, and open the MIXER Screen. (see "Menu operation procedures" on page 21)



2. Select PHASE on the MIXER Screen, and open the PHASE Screen.

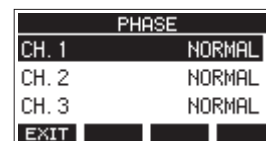

3. Select the channel with the signal phase to change, and open its settings screen.

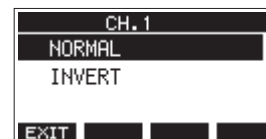

4. Turn the MULTI JOG dial to change the signal phase.

Option	Meaning
NORMAL (default)	Normal phase
INVERT	Inverted phase

5. Press the MULTI JOG dial to confirm the setting. The PHASE Screen reopens.

9 - Other functions

Changing the positions that signals are sent to the AUX 1 bus from each channel

The positions from which signals are sent from the channels to the AUX 1 bus can be changed.

This setting is shared by channels 1–6, 7/8 and 9/10.

1. When the recorder is stopped, select MIXER on the MENU Screen, and open the MIXER Screen. (see “Menu operation procedures” on page 21)



2. Select AUX1 SEND on the MIXER Screen, and open the AUX1 SEND Screen.



3. Turn the MULTI JOG dial to select the signal sent to the AUX 1 bus.

Option	Meaning
PRE FADER (default)	The signal is sent to the AUX 1 bus before adjustment by the channel fader.
POST FADER	The signal is sent to the AUX 1 bus after adjustment by the channel fader.

4. Press the MULTI JOG dial to confirm the setting. The MIXER Screen reopens.

Setting the solo function for all channels

This sets the function of the SOLO buttons.

This setting is shared by channels 1–6, 7/8 and 9/10.

1. When the recorder is stopped, select MIXER on the MENU Screen, and open the MIXER Screen. (see “Menu operation procedures” on page 21)



2. Select SOLO MODE on the MIXER Screen, and open the SOLO MODE Screen.

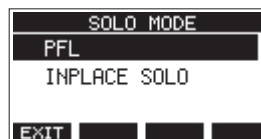

3. Turn the MULTI JOG dial to select the solo mode.

Option	Meaning
PFL (default)	Pressing the SOLO button sends the channel signal to the SOLO L/R bus.
INPLACE SOLO	Pressing the SOLO button mutes the signals of other channels.

4. Press the MULTI JOG dial to confirm the setting. The MIXER Screen reopens.

Footswitch functions

Setting up the footswitch

Use the FOOTSW Screen to set the footswitch. Two footswitches can be connected by using a commercially-available splitter cable. The function and polarity can be set separately for each footswitch.

NOTE

When connecting a footswitch directly without using a splitter cable, the FOOTSW1 settings will be used. In this case, set FOOTSW2 to OFF.

1. When the recorder is stopped, select FOOTSW on the SYSTEM Screen, and open the FOOTSW Screen. (see "Menu operation procedures" on page 21)



2. Select FOOTSW1 or FOOTSW2 from the list, and open the corresponding footswitch settings screen.



3. Select the MODE item, and open the MODE Screen.

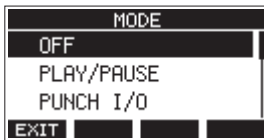

4. Turn the MULTI JOG dial to select the function to assign to the footswitch.

Option	Meaning
OFF	No function is assigned to the footswitch.
PLAY/PAUSE (default)	Press to start playback when stopped or paused. Press to pause when playing.
PUNCH I/O	Press during playback to punch in. Press when recording to punch out.
FX MUTE	Mute the built-in effect signal.
REC/STOP	Start/stop recording.
MARKER	Add a mark to the song.
MARK SKIP	Move to the next mark.
SONG INCREMENT	Load the next song.
TAP	Use in the same way as the CLICK button on the EFFECT and TEMPO screens.

5. Press the MULTI JOG dial to confirm the assigned function. The FOOTSW screen reopens.

Setting the footswitch polarity

The setting of this unit can be changed according to the polarity of the footswitch being used.

1. When the recorder is stopped, select FOOTSW on the SYSTEM Screen, and open the FOOTSW Screen. (see "Menu operation procedures" on page 21)
2. Select FOOTSW1 or FOOTSW2 from the list, and open the corresponding footswitch settings screen.



3. Select the POLARITY item, and open the POLARITY Screen.



4. Turn the MULTI JOG dial to set the footswitch polarity. Select "NORMALLY OPEN" or "NORMALLY CLOSED" so that the actual footswitch movement matches that shown by the illustration on the screen.

Options: NORMALLY OPEN (default), NORMALLY CLOSED

NOTE

When using a TASCAM RC-1F, set the POLARITY switch to "N.OPEN".

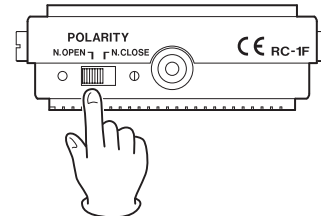

5. Press the **F1 EXIT** button to return to the FOOTSW Screen.

NOTE

Dual-type footswitches can also be connected. Refer to the operation manual of the footswitch for how to connect and set it.

DAW CONTROL

This unit has DAW control functions. By setting it to DAW control mode, the controls of this unit can be used for basic operation of the DAW application. This includes fader operation, muting, panning, soloing, recording, playing, stopping and other transport functions.

Mackie Control and HUI protocol emulation are supported, so Cubase, Digital Performer, Logic, Live, Pro Tools, Cakewalk and other major DAW applications can be controlled.

For details about DAW control mode, download the DAW Control Mode Manual from the page for this product on the TASCAM website (<https://tascam.com/us/>).

10 - Settings and Information

Viewing information

Use the INFORMATION screen to view various types of information about the unit. Follow the procedures below to view the INFORMATION screen.

1. When the recorder is stopped, select INFORMATION on the SYSTEM Screen, and open the Information Screen. (see "Menu operation procedures" on page 21)

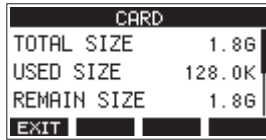

The Information Screen has 3 pages. The CARD page opens first.

2. Turn the MULTI JOG dial to cycle through the CARD, SONG and FIRMWARE screens.

CARD Screen

Shows the use status of the currently loaded SD card.

SONG Screen

Shows the number of songs on the loaded SD card.

FIRMWARE Screen

Shows the unit's system firmware version.

3. Press the **F1 EXIT** button to return to the SYSTEM Screen.

CARD Screen

The CARD Screen shows the status of the currently loaded SD card.

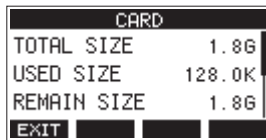

TOTAL SIZE

Shows the total amount of space on the SD card.

USED SIZE

Shows the amount of space used on the SD card.

REMAIN SIZE

Shows the amount of space unused on the SD card.

SONG Screen

The SONG Screen shows the use status of the "MTR" folder.



TOTAL SONG

This shows the total number of songs in the "MTR" folder.

FIRMWARE Screen

The FIRMWARE Screen shows the firmware version.

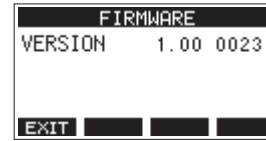

VERSION

This shows the system firmware version of this unit.

Setting the song name format

Set the name format used by the unit for created songs.

1. When the recorder is stopped, select SONG NAME on the SYSTEM Screen, and open the SONG NAME Screen. (see "Menu operation procedures" on page 21)

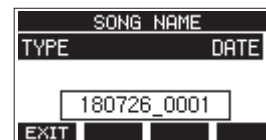

2. Set the file name format.

Option	Meaning
DATE (default)	Use the date for the song name. (Example: 180101_0001)
WORD	Use the 6-character song name set on the EDIT screen. (Example: TASCAM_0001)

NOTE

The date is set using the unit's internal clock. (see "Setting the built-in clock date and time" on page 25)

3. Press the **F1 EXIT** button to return to the SYSTEM Screen.

Setting the WORD item

To set the characters, select WORD on the TYPE Screen. An EDIT item will appear on the SONG NAME Screen that can open the WORD EDIT Screen.



For details about how to set characters, see "Editing text" on page 29.

Restoring factory default settings

You can restore the various settings stored in the memory of the unit to their factory default values.

Use the following menu procedures to do so.

1. When the recorder is stopped, select INITIALIZE on the SYSTEM Screen, and open the INITIALIZE Screen. (see "Menu operation procedures" on page 21)

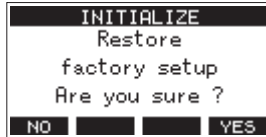

2. Press the **F4 YES** button to restore the factory default settings.
3. When the setting completes, the SYSTEM Screen will reopen.

NOTE

- Press the **F1 NO** button to cancel execution.
- The date and time setting is not initialized.

Formatting SD cards

Formatting erases all music files on the SD card and automatically creates new "MTR", "MUSIC" and "UTILITY" folders as well as a "tascam_m.sys" file.

ATTENTION

- Formatting an SD card erases all the data on it. This cannot be undone.
- Always use this unit to format media to be used with it. Operation of this unit might be affected when using an SD card that has been formatted by a computer or other device.

1. When the recorder is stopped, select MEDIA FORMAT on the SYSTEM Screen, and open the MEDIA FORMAT Screen. (see "Menu operation procedures" on page 21)



QUICK: Execute quick formatting.

ERASE (Recommendation): Erase and format the card.

2. Select the format method, and press the MULTI JOG dial. A confirmation message will appear on the QUICK or ERASE Screen.

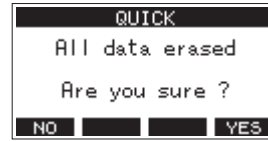

Shown when QUICK selected

NOTE

Press the **F1 NO** button to cancel formatting and return to the previous screen.

3. Press the **F4 YES** button to start formatting.
4. When formatting is complete, the SYSTEM Screen will reopen.

NOTE

- Pressing the **F1 STOP** button during an ERASE format will cancel erasure and execute a QUICK format instead.
- The writing speeds to SD cards and other storage media that use flash memory tend to decrease after writing occurs repeatedly.

If the writing speed decreases, this could have a negative impact on recording.

Using the ERASE function of this unit should restore the writing speed of the SD card.*

For this reason, we recommend using the ERASE function at the following times.

- Whenever the card has been written to until it became completely full
- On a regular schedule (about once per month)
- Before starting important recordings

* Writing speed might not be restored depending on the SD card condition (including malfunction and age).

10 - Settings and Information

Playing WAV files on SD cards (SD PLAY mode)

The WAV files in the "MUSIC" folder on an SD card can be played back. (see "Loading WAV files from a computer" on page 52)

To play files recorded on this unit, use the stereo mix export function to convert the recorded (mono) files to a single stereo file. Then, use the SD PLAY mode to play it. (see "Stereo mix export function" on page 39)

The following audio file formats can be played back in SD PLAY mode.

WAV: 44.1/48kHz, 16/24-bit

BWF: 44.1/48kHz, 16/24-bit

NOTE

Playback signal is sent from channels 9 and 10.

1. Set the channel 9/10 MODE switch to "MTR".
2. Set the channel 9/10 PAN/BAL knob to the center position.
3. When the recorder is stopped, select SD PLAY on the MENU Screen, and open the SD PLAY Screen. (see "Menu operation procedures" on page 21)



4. Select a file to play back.
 - Turn the MULTI JOG dial to select a WAV file.
 - Press the MULTI JOG dial when a folder is selected to show its contents.
 - Press the **F1** **EXIT** button to return to the MENU Screen.
 - Press the **F2** **←** button to move up one level.

NOTE

Only WAV files can be played back. Unsupported files will not be shown.

5. Press the **F4** **PLAY** button or **▶/||** button to start WAV file playback.
The SD PLAY Screen will show playback status.

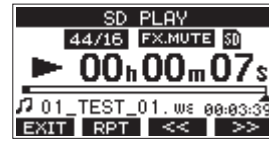

- Press the **F1** **EXIT** button to return to the file selection screen.
- Press the **F2** **RPT** button to turn the repeat playback function on and select the repeat playback mode.

Display	Meaning
No indicator	The folder that contains the currently playing WAV file will play back, and then playback will stop.
↻1	The currently playing WAV file will play back repeatedly.
↻ALL	The folder that contains the currently playing WAV file will play back repeatedly.

- Press the **F3** **<<** button to skip to the beginning of the WAV file. Press near the beginning of the WAV file to skip to the beginning of the track before it.
 - Press the **F4** **>>** button to skip to the beginning of the next WAV file.
6. Press the **F1** **EXIT** button twice to return to the MENU Screen.

11 - Using a computer to transfer data

By connecting this unit with a computer using a commercially available USB cable, you can back up song data on the SD card in the unit to the computer, as well restore backed up song data to the unit. You can also export track and stereo master files from songs to the computer and import audio files from the computer.

Backed up data can be restored to other Model 12 units. Since this allows you to freely move files between Model 12 units, you can easily conduct additional recording or mixing at different locations.

ATTENTION

You can conduct the same operations by removing the SD card from the unit and connecting it directly to a computer or by using a card reader instead of using USB to connect the unit and the computer. Turn the unit's power off or stop operation before removing the SD card.

This unit can transfer the following data to a computer.

Entire songs

This unit can transfer all the data for a song from the "MTR" folder to a computer. This operation is called "backing up". Data backed up to a computer can also be transferred to the "MTR" folder, and restored as a song file. This operation is called "restoring".

ATTENTION

Do not change names, delete or otherwise alter individual files inside the "MTR" folder. Doing so could prevent loading data as a song and make proper recording and playback operations impossible.

WAV files

By placing WAV files from the computer into the "MUSIC" folder, you can import them to song tracks. Moreover, WAV files in the "MUSIC" folder can be played back in SD PLAY mode.

Connecting with a Computer

You cannot use this unit's recording, playback and other recorder functions when it is connected to a computer by USB. To connect with a computer, use a Type-A to Type-C USB2.0 cable to connect the USB port on the back of this unit to a USB port on the computer.

The USB cable can be connected either before or after turning this unit on.

1. Use a USB cable (Type-A to Type-C) to connect the computer to this unit's USB port.

ATTENTION

The unit should be connected directly with the computer instead of via a USB hub. Moreover, noise could be picked up if the cable is too long.

2. On the MENU Screen, select STORAGE to open the STORAGE Screen. (see "Menu operation procedures" on page 21)



3. To connect with the computer, press the **F4 YES** button. The unit enters USB storage mode and connects with the computer.

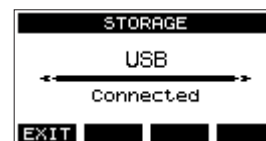

Make sure that the SD card is inserted properly.

4. This unit appears on the computer as an external drive named "TASCAM_M" (if the card was formatted by this unit).

NOTE

Follow these procedures to open This PC.

Windows 10

Left-click the Windows Start button, and from Windows System select "PC".

Windows 8.1

Left-click the Windows Start button, click the down arrow icon on the Start screen, and select This "PC" under Windows System in the application list.

Windows 7

Left-click the Windows Start button, and select "Computer" in the Start menu.

11 - Using a computer to transfer data

5. Click the "TASCAM_M drive" on the computer to show the "MTR", "MUSIC" and "UTILITY" folders.

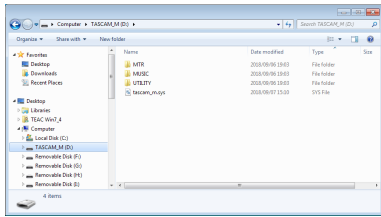

ATTENTION

- This unit receives power through its power cord. It cannot be powered by USB.
- Do not disconnect the power cord or turn off the power during data transfer. Data will be lost if the power is interrupted during transfer. Lost data cannot be restored.
- Do not change the names of folders in "TASCAM_M".

NOTE

- Do not change names, delete or otherwise alter individual files inside the "MTR" folder.
- The "UTILITY" folder is used when updating the unit system, for example.

6. Press the **F1 EXIT** button to return to the Meter Screen.

Disconnecting

Before disconnecting the USB cable, use the proper procedures for your computer to unmount the unit (as an external drive).

See the computer's operation manual for instructions about how to unmount an external volume.

Press the **F1 EXIT** button to disconnect from the computer and return to the Home Screen.

Loading WAV files from a computer

1. Use a USB cable (Type-A to Type-C) to connect the computer to this unit's USB port. (see "Connecting with a Computer" on page 51)
2. Click the "Model 12" drive on the computer to show the "MTR", "MUSIC" and "UTILITY" folders.
3. Drag and drop files on the computer that you want to transfer to the unit to the "MUSIC" folder.

ATTENTION

- The "UTILITY" folder is used when updating the unit system, for example.
- Do not change names, delete or otherwise alter individual files inside the "MTR" folder. Doing so could prevent loading data as a song and make proper recording and playback operations impossible.

TIP

- You can manage the content of "MTR" or "MUSIC" folders from the computer.
- You can create subfolders in the "MUSIC" folder up to the second level for use with this unit. The Model 12 cannot recognize sub-folders and files located at the third layer level or below.

12 - USB audio interface functions

Installing the dedicated software

To use this unit as a USB audio interface with a Windows computer, dedicated software must be installed on the computer.

Download the latest software from the product page on the TEAC Global Site (<http://teac-global.com/>).

Installing the dedicated software will install a driver and a Settings Panel application.

ATTENTION

Before starting to install software, quit other applications.

NOTE

With a Mac, the standard OS driver will be used, so installation of dedicated software is not strictly necessary. We recommend installing this software, however, because it has a notification function about updates for the unit firmware and software.

Installing the Windows dedicated software

Follow the procedures below to install the Windows dedicated software.

ATTENTION

- Complete installation of the Windows dedicated software on the computer before connecting the unit to it with the USB cable.
- If you connected the unit to the computer using the USB cable before installing the Windows dedicated software and the "Found New Hardware Wizard" launched, close the Wizard and disconnect the USB cable.

Windows dedicated software installation procedures

1. Download the latest Windows dedicated software from the TEAC Global Site (<http://teac-global.com/>) and save it on the computer to be used with the unit.
2. Uncompress the saved software (zip file) on the computer desktop or another location.
3. Double-click the "TASCAM_Model_Mixer_Installer_x.xx.exe" file in the folder that appears after uncompression to launch the installation software.

ATTENTION

If you open a zip file without decompressing it and doubleclick the "TASCAM_Model_Mixer_Installer_x.xx.exe" file in the folder that opens, installation will not start. Right-click the zip file and select "Extract All", for example, to decompress it and then try again.

4. When a "Security Warning" or "User Account Control" screen appears, click the "Yes" button.

5. Read the contents of the User License Agreement, and select "I accept the agreement" if you agree to the terms. Then, click the "Next >" button.

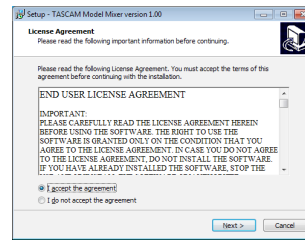

6. Next, click the "Install" button.

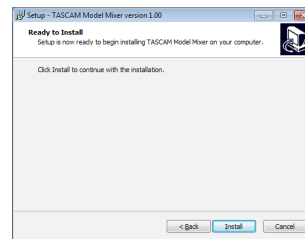

7. Next, click the "Install" button to start installation (Windows 7 only).

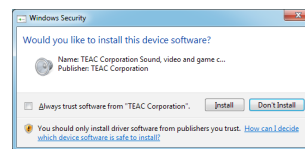

8. The following screen appears when installation has completed. The following screen appears when installation has completed. Click the "Finish" button.

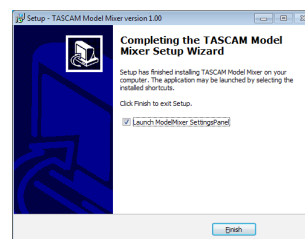

The installer will quit and the Windows Settings Panel will launch.

NOTE

The first time you connect the unit by USB to the computer after installing the software, installation of the device driver will be executed. Some time might be necessary before the unit is recognized because Windows Update will be automatically searched at this time. If the unit is still not recognized after a while, open the software installation screen from the notification area at the bottom right of the computer display, and click "Skip obtaining driver software from Windows Update" to stop the search.

12 - USB audio interface functions

Installing the Mac dedicated software

NOTE

- Install the Mac dedicated software on the computer before connecting the unit to it with the USB cable.
- Depending on the Gatekeeper setting, a warning message might appear during installation. Please see “Working with Gatekeeper” on page 54 for information about Gatekeeper.

Mac dedicated software installation procedures

1. Download the latest Mac dedicated software for the operating system you are using from the TEAC Global Site (<http://teac-global.com/>) and save it on the computer to be used with the unit.
2. Double-click “TASCAM_MODEL MIXER_Installer_x.xx.dmg”, which is the saved disk image file for the Mac dedicated software, and double-click “ModelMixer_Installer.pkg” inside the folder that opens.



ModelMixer_Installer.pkg

NOTE

Depending on the computer’s settings, the downloaded zip file might not have been uncompressed automatically. In this case, uncompress the zip file first and then double-click the disk image file.

3. When the installer starts, click the “Continue” button.

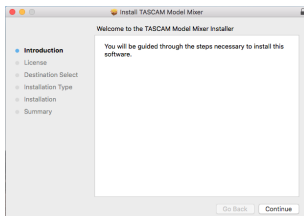

4. Next, select the desired language and click the “Continue” button.

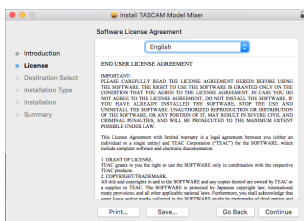

5. Click the “Read License” button and check the contents of the Software License Agreement. If you agree to the contents of the license, click “Agree”. Then, click the “Next” button.

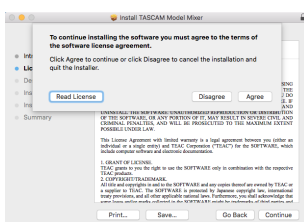

6. Next, click the “Install” button to start installation.

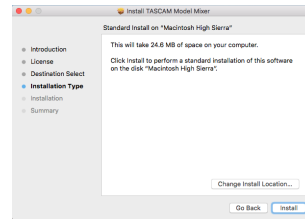

7. The following screen appears when installation has completed. Click the “Close” button.

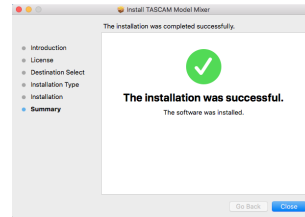

Working with Gatekeeper

When using macOS, depending on the Gatekeeper security function setting, a warning message might appear during installation.

The solution depends on the warning message shown. See the following explanations for details.

When the Gatekeeper setting is “Allow applications downloaded from: the Mac App Store”

The following security warning might be shown:

“ModelMixer_Installer.pkg’ can’t be opened because it was not downloaded from the Mac App Store.”

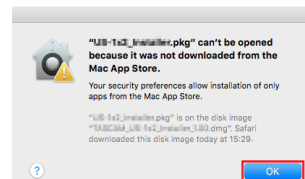

In this case, click the “OK” button to close the message. Then, control-click (or right-click) the file and click “Open” in the menu.

When the “ModelMixer_Installer.pkg’ can’t be opened because it was not downloaded from the Mac App Store. Are you sure you want to open it?” security warning message appears, click the “Open” button.

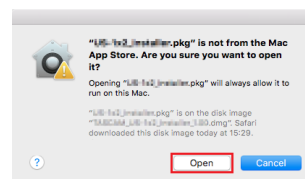

This warning message might also appear when the Gatekeeper setting is something other than “Allow applications downloaded from: the Mac App Store.”

12 - USB audio interface functions

The file still might not open and “ModelMixer_Installer.pkg” can’t be opened because it was not downloaded from the Mac App Store.” might appear again.

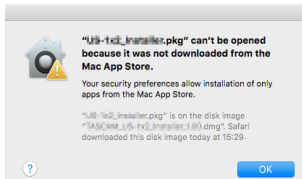

In this case, copy the file from the folder where it is to the desktop or another folder, and then open it. Alternatively, change the Gatekeeper settings to “Allow apps downloaded from: App Store and identified developers” and try opening it again.

When the Gatekeeper setting is “Allow applications downloaded from: the Mac App Store”

“TASCAM_MODEL MIXER_Installer_x.xx.dmg” is an application downloaded from the Internet. Are you sure you want to open it?” might appear as a security warning message. In this case, click the “Open” button.

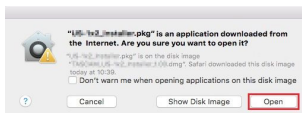

Changing the Gatekeeper setting

The Gatekeeper setting can be changed using the “Allow applications downloaded from:” item on the “General” page of the “Security & Privacy” pane of the System Preferences. To change this, you must click the lock icon (🔒) at the bottom left and enter a password to unlock the settings.

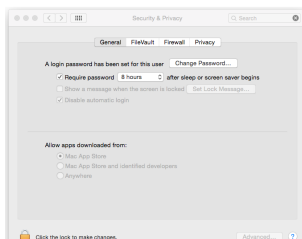

This setting will lock again when you close the System Preferences by clicking the 🔒 button or typing command-Q, for example, or when you click “Show All” to close the open pane.

ATTENTION

Changing the Gatekeeper settings could result in security risks. If you changed the Gatekeeper setting to decrease security (use one of the lower settings), set it back to the original setting after updating the driver and/or firmware.

Uninstalling the dedicated software

NOTE

Normally, there is no need to uninstall the dedicated software. Follow these procedures if a problem occurs or you no longer intend to use the unit with the computer.

Uninstalling the Windows dedicated software

1. Open the “Uninstall or change a program” screen using the procedures for the operating system being used (Windows 10/Windows 8.1/Windows 7).
2. Select “TASCAM Model_Mixer x.xx” from the list, and double-click it.
3. Then, follow the instructions that appear on the screen.

Uninstalling the Mac dedicated software

Delete “TASCAM Model_Mixer” from the Application folder to complete uninstallation.

Opening the Settings Panel

Open the Settings Panel in the following manner.

Windows

- From the “Start” menu select “TASCAM Model Mixer” under “TASCAM”

Mac

- On the Launchpad, click “TASCAM Model Mixer”.
- Using the Finder, open the Applications folder and click “TASCAM Model Mixer” to open the Settings Panel.
- In the Audio Devices window of the Audio MIDI Setup application, control-click (right-click) “TASCAM Model Mixer”. Alternatively, click the button and click “Configure device...” from the menu that appears to open the Settings Panel.

12 - USB audio interface functions

Settings Panel overview

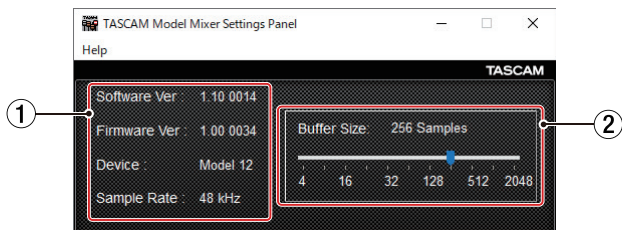

Windows Settings Panel

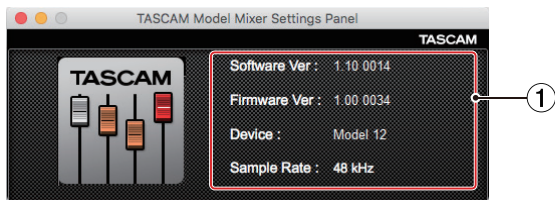

Mac Settings Panel

① Status display area

This shows the current status of the software.

Item displayed	Meaning
Software Ver	This is the software version.
Firmware Ver	This is the firmware version used by the connected unit.
Device	This is the name of the connected unit. ("No Device" is shown when no device is connected.)
Sample Rate	This shows the sampling frequency of the current song. If an SD card is not loaded, this shows the sampling frequency set by the computer.

② Buffer Size (Windows only)

You can adjust the size of the buffer used to handle the audio input and output signals transferred to and from the computer.

Smaller buffer sizes result in less audio signal delay (latency), but require high-speed processing by the computer.

If the processing cannot keep up, for example, due to other system operations, clicking and popping noises might occur and the audio signal might even drop out.

Increasing the buffer size will stabilize operation and suppress negative effects on audio signals, but the delay in audio signals sent to the computer will increase.

You can use the slider on the panel to adjust the buffer size for this unit according to the use conditions.

Options

4, 8, 16, 24, 32, 64, 128, 256 (default), 512, 1024, 2048

Notification function

If the computer you are using is connected to the Internet, the latest information about unit firmware and software, for example, can be shown when the Settings Panel is launched.

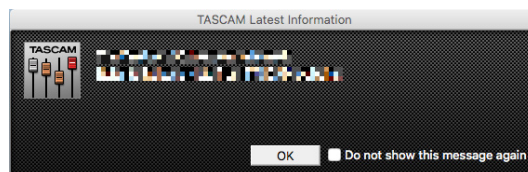

NOTE

Put a check in the "Do not show the same message again" checkbox to prevent the same message from being shown the next time it is launched.

Setting Sound Properties

1. Open the OS Control Panel.

NOTE

Follow these procedures to open the Control Panel.

Windows 10

Left-click the Windows Start button, and from "WindowsSystem" select "Control Panel".

Windows 8.1

Right-click the Windows Start button, and select "Control Panel".

Windows 7

Left-click the Windows Start button, and select "Control Panel" in the Start menu.

2. Double-click "Sound" in the Control Panel.

NOTE

If the Control Panel is set to be viewed as icons, a "Sound" icon will appear.

3. On the "Playback" page, right-click "Model 12", and click "Set as Default Device" in the pop-up menu that appears. When you do this, the green check mark appears next to the selected device.

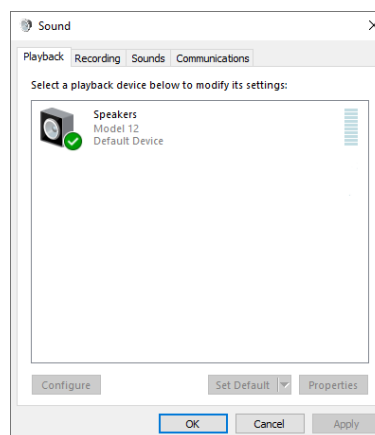

Windows 10 screen

NOTE

Set the default device according to the ASIO device being used on the Recording tab in the same manner as on the Playback tab.

12 - USB audio interface functions

4. After completing the setting, click the "OK" button.
5. Launch Windows Media Player and start playback to input the playback sound from the computer to channels 1 and 2 on the Model 12. (MODE switches: PC)

NOTE

- If you change the setting while Windows Media Player is running, the software will not recognize that the device has been changed. In this case, restart Windows Media Player.
- If you still cannot hear sound after making the settings and completing the procedures above, restart the computer.
- If you make this setting, sound will be output through this unit, but no sound will be output from the computer's speakers or headphone jack.

Simultaneous ASIO/WDM playback

The driver for this unit can simultaneously play ASIO output from a DAW and WDM output from Windows Media Player, for example. The sample rates of both sources must be set to the same value for simultaneous playback to be possible. Moreover, the sample rate must also be set to the same value for both playback and recording in the Windows Sound Properties.

When the sample rates are the same

Example: Windows (WDM) at 44100 Hz, ASIO at 44100 Hz

The Windows audio and ASIO sound are mixed and played simultaneously.

When the sample rates are different

Example: Windows (WDM) at 48000 Hz, ASIO at 44100 Hz

Only sound from a DAW and other ASIO sources are output.

Sound from Windows Media Player and other WDM sources are not output.

When the DAW is shut down, for example, and output from ASIO sources stops, sound from Windows Media Player and other WDM sources will become audible.

USB audio mode

The sound input to the computer can be changed to allow the MAIN MIX L/R bus signal to be sent to communication applications and streaming software.

1. When the recorder is stopped, select USB AUDIO on the SYSTEM Screen, and open the USB AUDIO Screen. (see "Menu operation procedures" on page 21)



2. Turn the MULTI JOG dial to set USB audio mode.

Option	Meaning
MULTI INPUT (default)	The inputs of channels 1–6, 7/8 and 9/10 and the output of the MAIN MIX L/R bus are input to USB channels 1–12.
STEREO MIX	The output of the MAIN MIX L/R bus is input to USB channels 1–2.

13 - MIDI Implementation Chart

MIDI Implementation Chart

Function		Transmit	Recognize	Remarks
Basic channels	When power on	×	×	Thru
	Settable	×	×	
Mode	When power on	×	×	Thru
	Messages	×	×	
	Altered		
Note number	Range	×	×	Thru
Velocity	Note on	×	×	Thru
	Note off	×	×	
Aftertouch	Polyphonic	×	×	Thru
	Channel	×	×	
Pitch bend		×	×	Thru
Control change		×	×	Thru
Program change		×	×	Thru
	Setting range		
System exclusive		○ ^{*1}	×	Thru
System common	Position	○ ^{*3}	×	Thru
	Song select	×	×	
	Quarter frame	○ ^{*2}	×	
	Tune	×	×	
System real-time	Clock	○ ^{*3}	×	Thru
	Command	×	×	
Other	Local on/off	×	×	Thru
	All notes off	×	×	
	Active sense	×	×	
	Reset	×	×	
Notes				
*1 MTC full message when MIDI TIME CODE is ON				
*2 When MIDI TIME CODE is ON				
*3 When MIDI CLOCK/SPP is ON				

Mode 1: OMNI ON, POLY Mode 2: OMNI ON, MONO
 Mode 3: OMNI OFF, POLY Mode 4: OMNI OFF, MONO

○: YES
 ×: NO

14 - Messages

The following is a list of messages that appear in pop-up windows.

Refer to this list if one of these pop-up messages appears on the Model 12 and you want to check the meaning or determine a proper response.

Message	Meaning and response
Card Error	The SD card cannot be recognized properly. Replace the SD card.
Card Full	The SD card has no remaining capacity. Erase unnecessary files or transfer them to a computer.
Dup File Name	A file with the same name already exists. Change the file name.
File Not Found	The file cannot be found or the file may be damaged. Check the relevant file.
No sys file	The system file is missing. This unit requires a system file for operation.
Make sys file	When this message appears, press the MULTI JOG dial to create a system file.
Song Protected	This operation is not possible because the song is protected. Remove protection.
Invalid Card Change Card	Something might be wrong with the SD card. Change the SD card.
I/O Too Short	The time between the punch in and out points is too short. Set them with at least 1 second between them.
MBR error Init card	The SD card is not formatted properly or the card is broken. Change the SD card or press the MULTI JOG dial while this message is being shown to format the card. Formatting will erase all the data on the SD card.
No Card	A SD card is not set. Insert a recordable SD card.
Non-supported	The file format is not supported. Please see "Playing WAV files on SD cards (SD PLAY mode)" on page 50 for file formats that this unit can use.
Card Protected	The SD card is write-protected. Disable SD card write-protection.
USB Fs mismatch	The sampling rate of the current song and the USB audio interface are not the same. Change the sampling rate of one so that they are the same.
Current Song	The current song cannot be deleted. To delete the current song, load another song first.
Invalid I/O point	The punch in/out point settings on the AUTO PUNCH Screen are not set correctly. Automatic punching in/out occurred at an invalid position for the punch in or out point. Start the automatic punch operation from a valid point.
Write error REC continue	Writing to the SD card timed out. This has caused audio to be interrupted and noise to occur.
REC stop Card slow	Writing to the SD card timed out, and recording stopped. SD card writing performance has become worse. Execute the erase format function or change the SD card.
Need to set I/O point.	Neither the punch in or out points are set for the automatic punch in/out function. Either the punch in or out point must be set.
Sample rate Unmatch	The sampling frequency of the WAV file to be imported does not match the current song. Select a WAV file with the same sampling frequency as the current song or convert the sampling frequency before importing.
Remain time is not enough	The SD card does not have enough open space, so importing is not possible. Erase unnecessary files or transfer them to a computer.
8 track punch in limit	The maximum number of tracks for punch in recording is eight. Press REC buttons to reduce the number of recording tracks to eight or less.
Song is not loaded	No song is loaded. Create a new song or load a song.
Song number full	The maximum number of songs that can be created on an SD card is 100. Erase unnecessary songs.
SD PLAY: cannot record	SD PLAY mode is for playback only. Recording is not possible.
SD CARD cluster size error	Recording is not possible because the SD card cluster size is not right. Back up the contents of the SD card on a computer and then format it with this unit. Then, restore the data from the computer.
Import error. No track	Importing is not possible because there are no open tracks. Use TRACK CLEAR to clear a track. (see "Clearing tracks" on page 38)
Invalid track	The selected track cannot be used for replacement. Change the track selection on the TRACK SWAP screen. (see "Swapping tracks" on page 39)
Already protected	The selected song is already protected.
Already unprotected	The selected song is already unprotected.

14 - Messages

Message	Meaning and response
Can't Save Data	If any of these errors occurs, turn the unit off and restart it. If these error messages continue to appear frequently, please contact the store where you purchased this unit or TASCAM customer support.
Device Error	
File Error	
Not Continued	
Player Error	
UNDO not available	
Writing Failed	
Sys Rom Err	
System Err XX (XX is a number.)	

15 - Troubleshooting

If you are having trouble with the operation of this unit, please try the following before seeking repair.

If these measures do not solve the problem, please contact the store where you bought the unit or TEAC customer support (see the back cover).

The unit will not turn on

- Confirm that the power plug and other connectors are inserted completely.

The SD card is not recognized

- Confirm that the SD card is inserted completely.

No sound is output

- Are the input sources and MODE switches set properly?
- Are that channel faders raised to suitable levels?
- Is the MAIN fader raised to a suitable level?
- Is a monitoring system correctly connected to the PHONES jack or SUB OUTPUT jacks?
Is the monitoring system set up correctly?
- Is the PHONES knob or SUB fader placed to a suitable level?
- Is the SD MAIN MIX RETURN switch on (pushed in, during playback of anything other than a stereo master file)?

The sound I want to record is distorted

- Are the channel GAIN knobs set too high?
Are the input source levels too high?
- Is the EQ set too high?
- Are any channel faders or the MAIN fader raised too high?
- Is the monitoring level too high, causing the monitoring system to distort?

Noise occurs when a passive guitar or bass is connected directly

- Connecting another device to the unit's SUB OUTPUT jacks (stereo output) could reduce noise.
- It could be affected by interference noise from another device, for example. If a power amplifier or other device with a large transformer, or a fluorescent light, for example, is nearby, changing the distance or orientation of such devices could reduce noise.

Playback is not possible

- If you are trying to play a WAV file, confirm that it uses a sampling frequency (44.1/48 kHz) and a bit depth (16/24-bit) that are supported by this unit.

There is noise

- Confirm that the connection cables do not have contact issues.

Sound via Bluetooth breaks up or is noisy

- Are there any wireless LAN devices, other Bluetooth devices, microwave ovens or similar equipment nearby?
Keep such devices as far away as possible during use.
- Try reducing the distance between this unit and the other Bluetooth device. Try changing the positions of this unit and the other Bluetooth device.
- The operation of apps other than for music playback on the smartphone could cause the sound to break up. In this case, stop operation of apps other than the one used for music playback.

Cannot connect or communication is interrupted when using Bluetooth

- Confirm that the other Bluetooth device power is on and that its Bluetooth function is on.
- Confirm that the other Bluetooth device is not too far away. Are there walls or other obstacles, for example, between this unit and the other Bluetooth device?
Try changing the positions of this unit and the other Bluetooth device.
- Turn OFF and restart the Model 12.
- Remove the "Model 12" pairing record from the other Bluetooth device, and try pairing the unit with that Bluetooth device again. (see "Connecting with Bluetooth devices" on page 24)

Cannot pair with another Bluetooth device

- Confirm that the other Bluetooth device supports A2DP.
- Confirm that the other Bluetooth device is in a state that allows transmission. For details, check the operation manual of that Bluetooth device.
- Turn the power off for both this unit and the other Bluetooth device once, turn them both on again and try pairing them.
- Turn off Bluetooth devices other than the one that you are trying to pair with.
- Remove the "Model 12" pairing record from the other Bluetooth device, and try pairing the unit with that Bluetooth device again. (see "Connecting with Bluetooth devices" on page 24)

A computer does not recognize the unit when connected by USB

- Has the dedicated software been installed? (see "Installing the dedicated software" on page 53)
- This unit cannot be used with USB 1.1. Use a USB 2.0 or USB 3.0 port.
- Do not use a USB hub with this unit. Always connect the unit directly to a USB port on the computer.
- If the above methods do not resolve the problem, connect the unit to a different USB port on the computer.

When connected by USB, sound breaks up or noise occurs.

- The processing load on the computer causes sound to break up and noise to occur.
- If a wireless LAN or background software, including antivirus software, is running, turn it off during use of this unit. In addition, please use "computer's power option" as "high performance setting".
- Use the shortest USB cable possible.
- Use a USB port built into the computer because the computer USB port affects the USB connection.

16 - Specifications

General

Supported media

SD cards (Class 10 or more)
SDHC cards (Class 10 or more)
SDXC cards (Class 10 or more)

File System

SD card: FAT16
SDHC card: FAT32
SDXC card: exFAT

Recording file formats

WAV (BWF): 44.1/48kHz, 16/24-bit (Maximum file size: 2 GB)

Playback file formats

WAV (BWF): 44.1/48kHz, 16/24-bit

Recordable Channel

Max. 12 channels (10ch + 2 stereo mix)

Inputs and outputs

Analog audio input and output ratings

MIC input jacks (1-6, 7, 9)

Connectors: XLR-3-31 (1: GND, 2: HOT, 3: COLD)
Maximum input level: +10 dBu
Nominal input level: -8 dBu
Minimum input level: -58 dBu
Gain adjustment range: 0 - 50 dB
Input impedance: 1.8 k Ω

LINE (BAL)/INST input jacks (1-6)

Connectors: 6.3mm (1/4") standard TRS jacks
(Tip: HOT, Ring: COLD, Sleeve: GND)
Maximum input level: +22 dBu (LINE)/19.8 dBV (INST)
Nominal input level: +4 dBu (LINE)/ 1.8 dBV (INST)
Gain adjustment range: -10 - +40 dB
Input impedance: 22 k Ω (LINE)/1 M Ω (INST)

L/MONO(BAL)/INST input jacks (7, 9)

Connectors: 6.3mm (1/4") standard TRS jacks
(Tip: HOT, Ring: COLD, Sleeve: GND)
Maximum input level: +22 dBu (LINE)/19.8 dBV (INST)
Nominal input level: +4 dBu (LINE)/ 1.8 dBV (INST)
Gain adjustment range: -20 - +30 dB
Input impedance: 18 k Ω (LINE)/ 1 M Ω (INST)

R (BAL) input jacks (8, 10)

Connectors: 6.3mm (1/4") standard TRS jacks
(Tip: HOT, Ring: COLD, Sleeve: GND)
Maximum input level: +22 dBu
Nominal input level: +4 dBu
Gain adjustment range: -20 - +30 dB
Input impedance: 18 k Ω

INSERT jacks (1-2)

Connectors: 6.3mm (1/4") standard TRS jacks
(Tip: SEND, Ring: RETURN, Sleeve: GND)
RETURN (Ring)
Nominal input level: 0 dBu
Maximum input level: +18 dBu
Input impedance: 5 k Ω
SEND (Tip)
Nominal output level: 0 dBu
Maximum output level: +18 dBu
Output impedance: 100 Ω

MUSIC/TALK jack (9/10)

Connector: 3.5mm (1/8") 4-pole mini jack
(Tip: L, Ring1: R, Ring2: GND, Sleeve: MIC)
Maximum input level: +8 dBV
Nominal input level: -10 dBV
Input impedance: 10 k Ω

MAIN OUTPUT L/R jacks

Connectors: XLR-3-32 (1: GND, 2: HOT, 3: COLD)
Nominal output level: +4 dBu
Maximum output level: +22 dBu
Output impedance: 200 Ω

SUB OUTPUT L/R jacks

Connectors: 6.3mm (1/4") standard TRS jacks (Tip: HOT, Ring: COLD, Sleeve: GND)
Nominal output level: -2 dBu
Maximum output level: +16 dBu
Output impedance: 200 Ω

AUX OUTPUT AUX 1/2 jacks

Connectors: 6.3mm (1/4") standard TRS jacks (Tip: HOT, Ring: COLD, Sleeve: GND)
Nominal output level: -2 dBu
Maximum output level: +16 dBu
Output impedance: 200 Ω

PHONES jack

Connector: 6.3mm (1/4") standard stereo jack
Maximum output: 45mW + 45mW (32 Ω load)

Control input/output

USB port

Connector: 4-pin USB C-type
Protocol: USB 2.0 HIGH SPEED (480 Mbps)

CLICK jack

Connector: 6.3mm (1/4") standard TS jacks
(Tip: HOT, Sleeve: GND)

FOOTSWITCH jack

Connector: 6.3mm (1/4") standard TRS jacks
(Tip: FOOTSW1, Ring: FOOTSW2, Sleeve: GND,
Unlatch type correspondence)

MIDI OUT connector

Connector: 5-pin DIN
Format: standard MIDI

MIDI IN connector

Connector: 5-pin DIN
Format: standard MIDI

Computer system requirements

Check the TEAC Global Site (<http://teac-global.com/>) for the latest information about supported operating systems.

Windows

Supported operating systems

Windows 10 32-bit
Windows 10 64-bit
Windows 8.1 32-bit
Windows 8.1 64-bit
Windows 7

(Operation has been confirmed with the final version of Windows 7.)

Windows 7 32-bit SP1 or later
Windows 7 64-bit SP1 or later

Computer hardware requirements

Windows computer with a USB 2.0 (or higher) port

CPU/processor speed

2 GHz or faster dual core processor (x86)

Memory

2 GB or more

ATTENTION

Operation of this unit was confirmed using standard computers that meet the above requirements. This does not guarantee operation with all computers that meet the above requirements. Even computers that meet the same system requirements might have processing capabilities that differ according to their settings and other operating conditions.

Mac

Supported operating systems

macOS Mojave (10.14 or later)
macOS High Sierra (10.13 or later)

Computer hardware requirements

Mac with a USB 2.0 (or higher) port

CPU/processor speed

2 GHz or faster dual core processor

Memory

2 GB or more

iOS device

Operation has been confirmed with Apple devices running the following iOS versions.

iOS13
iOS12
iOS11

Supported audio drivers

Windows

ASIO2.0, WDM

Mac

Core Audio

iOS device

Core Audio for iPhone

Audio performance

S/N ratio

103dB (MAIN MIX & 1Ch 0dB, 22kHz, A-weighted)

Equivalent input noise (EIN)

-128 dBu (Rs=150 Ω, MIC IN → INSERT SEND, gain knob at MAX, A-weighted)

Total harmonic distortion ratio (THD+N)

0.003% (MONO MIC IN → MAIN OUT, +2dBu, 1kHz, gain knob at MIN)

Frequency response

20Hz to 20kHz (+0.1/-0.15 dB, 1kHz, MIC IN → MAIN OUT)

Crosstalk

(PAN knobs turned completely left or right, 1 kHz)
Between channels: -95 dB
Between input and output: -95 dB

Maximum gain

(All GAIN knobs maximized, PAN knobs turned completely left or right, EQ knobs and MASTER SECTION EQ knobs at middle positions)

MIC → MAIN OUT: 74 dB
MIC → INSERT OUT: 54 dB
MIC → SUB OUT: 74 dB
MIC → AUX OUT: 75 dB
USB/SD → MAIN OUT: 24 dB

16 - Specifications

Bluetooth

Bluetooth version: 5.0

- Output class: 2 (about 10m* unobstructed transmission distance)
- Supported profile: A2DP
- Supported A2DP codecs: SBC, AAC
- Supported A2DP content protection: SCMS-T

* The transmission distance is only an estimate and might vary depending on the surrounding environment and radio wave conditions.

Other

Power

- Dedicated AC adapter (PS-M1524A)
- Input voltage: AC 100–240V ~, 50/60Hz
- Output voltage: DC 15V =
- Output current: 2.4 A

Power consumption

16W

Dimensions

- With side panels
343.0 × 98.8 × 360.0 mm (W x H x D, including protrusions)
- Without side panels
315.0 × 98.8 × 360.0 mm (W x H x D, including protrusions)

Weight

4.3kg

Operating temperature range

5 - 35°C (41 - 95°F)

Dimensional drawings

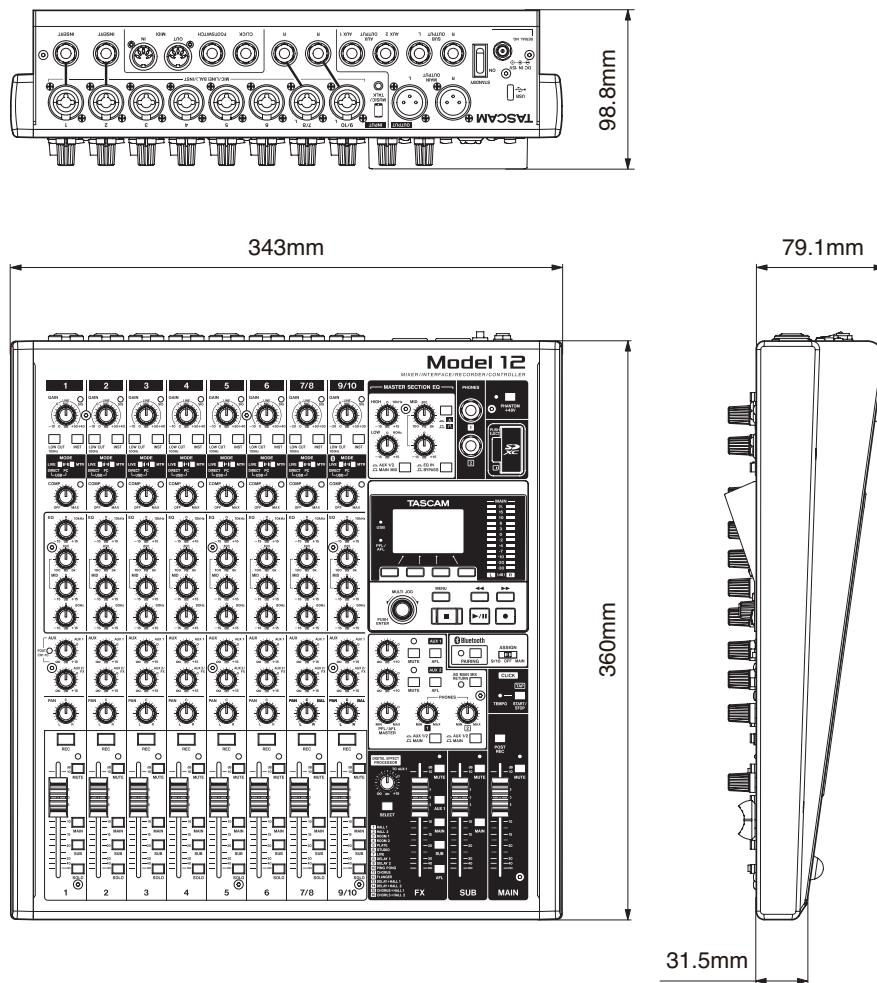

- Illustrations in this manual might differ in part from the actual product.
- Specifications and external appearance might be changed without notification to improve the product.

Block diagram

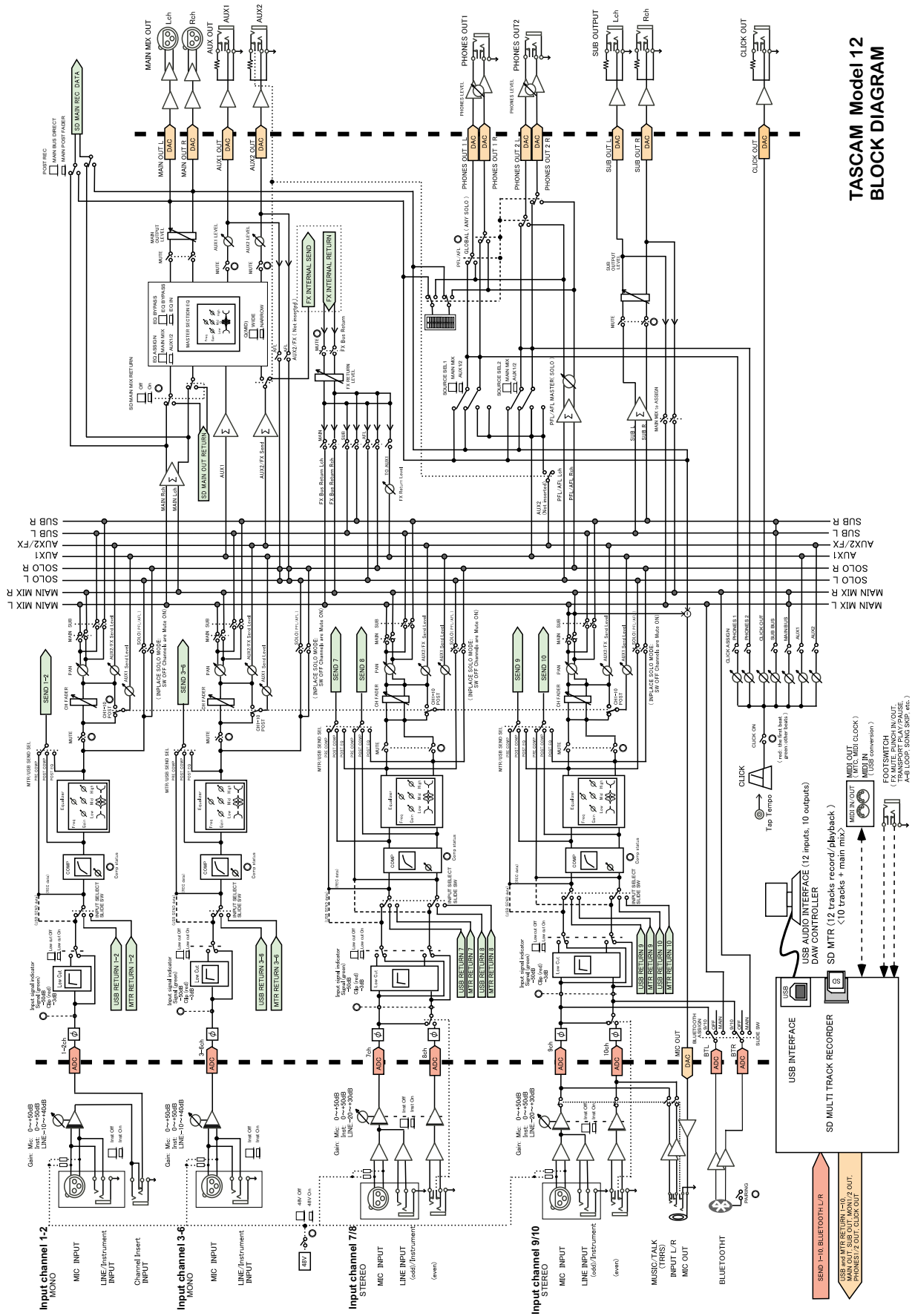

16 - Specifications

Level diagram

Model 12 LEVEL DIAGRAM

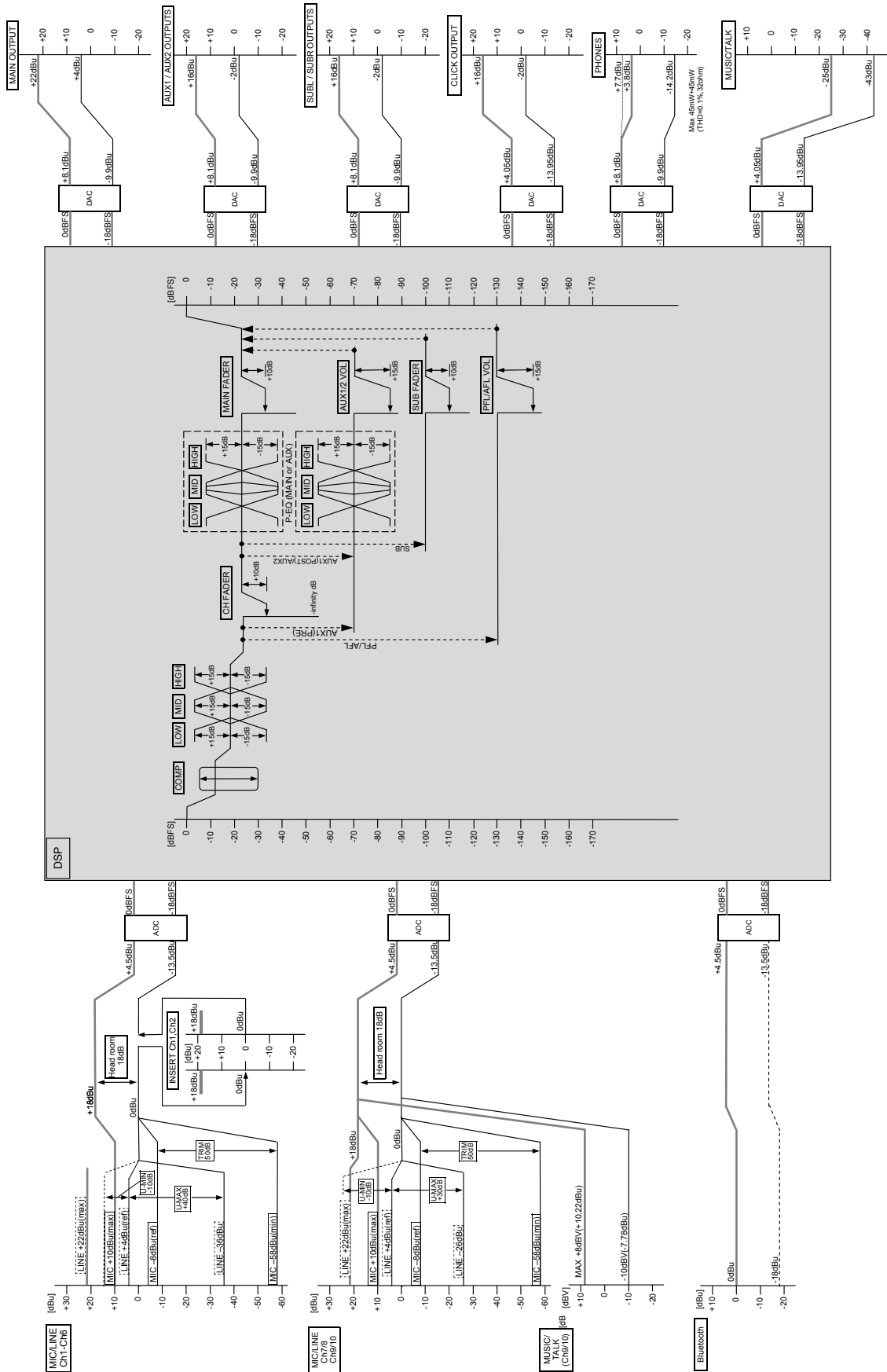

WARRANTY

< In the United States >

This warranty gives you specific legal rights and you may also have other rights which vary from state to state. This warranty is only valid within the country the unit was originally purchased.

WHAT IS COVERED AND WHAT IS NOT COVERED

Except as specified below, this warranty covers all defects in materials and workmanship in this product. The following are not covered by the warranty:

1. **Damage to or deterioration of the external cabinet.**
2. **Damage resulting from accident, misuse, abuse or neglect.**
3. **Damage resulting from failure to perform basic daily maintenance and/or calibration or otherwise resulting from failure to follow instructions contained in your owner's manual.**
4. **Damage occurring during shipment of the product. (Claims must be presented to the carrier)**
5. **Damage resulting from repair or attempted repair by anyone other than TEAC or an authorized TASCAM service station.**
6. **Damage resulting from causes other than product defects, including lack of technical skill, competence, or experience of the user.**
7. **Damage to any unit which has been altered or on which the serial number has been defaced, modified or is missing.**

WHO IS COVERED UNDER THE WARRANTY

This warranty may be enforced only by the original purchaser. This warranty is not valid if the product was purchased through an unauthorized dealer.

LENGTH OF WARRANTY

All parts except heads and disk drives are warranted for one (1) year from the date of original purchase. Heads and disk drives are warranted for ninety (90) days from date of original purchase. Labor is warranted for ninety (90) days from date of original purchase.

WHAT WE WILL PAY FOR

We will pay all labor and material expenses for items covered by the

warranty. Payment of shipping charges is discussed in the next section of this warranty.

HOW YOU CAN GET WARRANTY SERVICE

Your unit must be serviced by an authorized TASCAM service station in the United States. (This warranty is not enforceable outside the U.S.) If you are unable to locate an authorized TASCAM service station in your area, please contact us. We either will refer you to an authorized service station or instruct you to return the unit to the factory. Whenever warranty service is required, you must present a copy of the original dated sales receipt from an Authorized TASCAM Dealer.

You must pay any shipping charges if it is necessary to ship the product to service. However, if the necessary repairs are covered by the warranty, we will pay return surface shipping charges to any destination within the United States.

LIMITATION OF IMPLIED WARRANTIES

Any implied warranties, INCLUDING WARRANTIES OF MERCHANTABILITY AND FITNESS FOR A PARTICULAR PURPOSE, are limited in duration to the length of this warranty.

EXCLUSION OF DAMAGES

TEAC's liability for any defective product is limited to repair or replacement of the product, at TEAC's option. TEAC shall not be liable for:

1. **Damages based upon inconvenience, loss of use of the product, loss of time interrupted operation or commercial loss; or**
2. **Any other damages, whether incidental, consequential or otherwise.**

Some states do not allow limitations on how long an implied warranty lasts and/or do not allow the exclusion or limitation of incidental or consequential damages, so the above limitations and exclusions may not apply to you.

To locate an Authorized Service Center in Your Area

CALL 1-323-726-0303

< Europe >

This product is subject to the legal warranty regulations of the country of purchase. In case of a defect or a problem, please contact the dealer where you bought the product.

Ce produit est sujet aux réglementations concernant la garantie légale dans le pays d'achat. En cas de défaut ou de problème, veuillez contacter le revendeur chez qui vous avez acheté le produit.

Dieses Gerät unterliegt den gesetzlichen Gewährleistungsbestimmungen des Landes, in dem es erworben wurde. Bitte wenden Sie sich im Gewährleistungsfall an den Händler, bei dem sie das Gerät erworben haben.

Questo apparecchio è conforme alle norme sulla garanzia vigenti nel rispettivo Paese in cui esso è stato acquistato. Si prega di rivolgersi al proprio commerciante, presso il quale è stato acquistato l'apparecchio, nel caso in cui si voglia richiedere una prestazione in garanzia.

Las condiciones de garantía de este aparato están sujetas a las disposiciones legales sobre garantía del país en el que ha sido adquirido. En caso de garantía, debe dirigirse al establecimiento donde adquirió el aparato.

< In other countries/areas >

This warranty gives you specific legal rights, and you may also have other rights that vary by country, state or province.

If you have a warranty claim or request, please contact the dealer where you bought the product.

该保证书赋予了顾客特定的合法权利，并且因国家、州或省等地域的不同，顾客可能拥有其他权利。如需申请或要求保修，请与购买本产品的销售店进行联系。

If you require repair services for your TASCAM equipment, please contact the dealer where the product was purchased from or the TASCAM Distributor in your country. A list of TASCAM Distributors can be found on our website at: <http://teac-global.com/>

TASCAM

TEAC CORPORATION
Phone: +81-42-356-9143
1-47 Ochiai, Tama-shi, Tokyo 206-8530 Japan

<https://tascam.jp/jp/>

TEAC AMERICA, INC.
Phone: +1-323-726-0303
10410 Pioneer Blvd. Suite #1 Santa Fe Springs, California 90670, U.S.A.

<https://tascam.com/us/>

TEAC UK Ltd.
Phone: +44-1923-797205
Meridien House, Ground Floor, 69 - 71, Clarendon Road, Watford, Hertfordshire, WD17 1DS, United Kingdom

<https://www.tascam.eu/en/>

TEAC EUROPE GmbH
Phone: +49-611-71580
Bahnstrasse 12, 65205 Wiesbaden-Erbenheim, Germany

<https://www.tascam.eu/de/>

TEAC SALES & TRADING(SHENZHEN) CO., LTD
Phone: +86-755-88311561~2
Room 817, Xinian Center A, Tairan Nine Road West, Shennan Road, Futian District, Shenzhen, Guangdong Province 518040, China

<https://tascam.cn/cn/>

Printed in China

0220. MA-3089A

WARRANTY

Model / Modèle / Modell
Modello / Modelo / 型号

Model 12

Owner's name / Nom du propriétaire / Name des Eigentümers
Nome del proprietario / Nombre del propietario / 顾客姓名

Serial No. / No de série / Seriennummer
Numero di serie / Número de serie / 序列号

Address / Adresse / Adresse
Indirizzo / Dirección / 顾客地址

Date of purchase / Date de l'achat / Datum des Kaufs
Data dell'acquisto / Fecha de compra / 购买日期

Dealer's name / Nom du revendeur / Name des Händlers
Nombre del comerciante / Nombre del establecimiento / 销售店名

TASCAM
<http://teac-global.com/>

Dealer's address / Adresse du revendeur / Adresse des Händlers
Indirizzo del commerciante / Dirección del establecimiento / 销售店

Sample

